



SDC-HTC-MOD

With display
unit OPC-S

Communicating humidity, temperature and CO₂ transmitter

Less Complexity, More Choice – Duct Sensors just got smarter

SDC-HT-MOD Humidity and temperature – pure Modbus RTU/ASCII. No analog outputs. Lower cost, less wiring, perfect for digital systems.

SDC-HTC-MOD Temperature, humidity, and CO₂ in one duct housing. Also, Modbus-only. One device, three critical parameters. Ideal for demand-controlled ventilation and IAQ monitoring.

A capacitive sensor element is used for measuring relative humidity while temperature is measured by a band-gap sensor. The microprocessor samples the humidity and temperature once per second. It calculates an averaging signal over a pre-set number of seconds and writes the measured values to the designated Modbus registers.

CO₂ is measured by a photoacoustic sensor element. The CO₂ value is measured once every 5 seconds the signal is averaged over a preset number of samples. The CO₂ value is written to the designated Modbus register.

Going digital brings more than increased accuracy! Our sensors calculate a whole range of additional values directly on board:

- Dew point
- Enthalpy
- Mixing ratio
- Absolute humidity
- Wet bulb temperature

The measured values are read using the Modbus RTU interface.

Features

- Humidity, temperature and CO₂ measurement for air ducts
- Sensor reconditioning function against contamination
- Anti-Creep function for high humidity environments
- Minimum and maximum temperature, humidity and CO₂ memory
- Selectable averaging filter for the measurement signal
- Optional LCD display (OPC-S) or external display (OPA-S / OPU-S)
- Status LED
- Modbus RTU/ASCII RS485 for monitoring and configuration
- Copy of settings with accessory (AEC-PM2)
- Automatic device address increment when copying settings (AEC-PM2)

Applications

- Humidity, temperature and CO₂ measurement for supply and return air ducts in heating, ventilation and air conditioning applications
- Recording of minimum and maximum values for critical environments
- Supervision of critical humidity, temperatures and CO₂ values
- Measurements in high humidity environments

Minimum and maximum values

Using Modbus, the optional built-in operation terminal "OPC-S" or the external operation unit "OPA-S / OPU-S" the user can read and reset the minimum and maximum values. The minimum and maximum values are stored in the non-volatile memory. They are available after a power failure.

Safety

**DANGER! Safety advice**

This device is for use as a humidity and temperature sensor. It is not a safety device. Where a device failure could endanger human life and property, it is the responsibility of the client, installer and system designer to add additional safety devices to prevent such a device failure. Ignoring specifications and local regulations may cause equipment damage and endanger life and property. Tampering with the device and misapplication will void warranty.

Types and Ordering

By default, a sensor element with 3% RH accuracy and a PG9 cable gland for cables \varnothing 4 – 8 mm (AWG 6 – 1) (item name AMC-1) is included. Contact your local sales contact to order different probe length, sensing elements with different accuracies or if you prefer a sensor with conduit connectors or a built-in display module.

Product Name	Product No.	Description / Function
SDC-HTC-MOD-16-A3-1	40-30-0352	Duct Humidity/Temperature/CO2 transmitter \pm 3% RH accuracy, 16cm probe

Accessories

Product Name	Product No.	Description
<i>Built-in Operation Terminal</i>		
OPC-S	40-500029	Optional built-in operation terminal for SDC devices. Replaces housing cover
<i>Sensors & Probes</i>		
AES4-HT-A5	40-500144	Humidity/temperature sensor, \pm 5% RH accuracy
AES4-HT-A3	40-500152	Humidity/temperature sensor, \pm 3% RH accuracy
AES4-HT-A2	40-500153	Humidity/temperature sensor, \pm 2% RH accuracy
<i>External Operation Terminal</i>		
OPA-S	40-500006	External operation terminal
OPU-S	40-500030	External operation terminal (US version)
<i>Plug-In</i>		
AEC-PM2	40-500130	Plug-In memory module for saving and fast copying of parameter sets
<i>Cable & Connectors</i>		
AMC-1	20-100035	Cable gland PG9 for cables \varnothing 4 – 8 mm (AWG 6 – 1)
AMC-2	20-100067	Conduit connector NPT 1/2

Technical specifications

Power supply	Power requirements	24 VAC ±10% 50/60 Hz, 15...34 VDC
	Power consumption	Max. 5 VA
	Safety extra low voltage (SELV)	HD 384, Class II
	Electrical connection	Push-in terminal for wire 0.32...1.3 mm ² (AWG 22...16)
Sensing probe	Humidity Sensor:	Capacitive sensor element
	Range	0...100 % RH
	Measuring Accuracy	See Figure 1
	Hysteresis	± 0.1%
	Repeatability	± 0.1%
	Stability	< 0.5% / year
CO2 sensor	Sensor type	Photoacoustic NDIR sensor with automatic baseline correction
	Measuring range	0 – 5000 ppm vol.
	Response time (63%)	1 Minute
Environment	Repeatability	± 10 ppm typical
	Accuracy	± 50 ppm ± 2.5% of measured value
	400...999 ppm	± 50 ppm ± 3% of measured value
	1000...1999 ppm	± 40 ppm ± 5% of measured value
Standards	2000...5000 ppm	± 40 ppm ± 5% of measured value
	Operation	To IEC 721-3-3
	Climatic conditions	class 3K5
	Temperature	-25...70 °C (-13...158 °F)
	Temperature with built-in display	0...50 °C (32...122 °F)
	Humidity	<85 % RH non-condensing
	Transport & storage	To IEC 721-3-2 and IEC 721-3-1
	Climatic conditions	class 3K3 and class 1K3
	Temperature	-25...70 °C (-13...158 °F)
	Temperature with built-in display	0...50 °C (32...122 °F)
	Humidity	<95 % RH non-condensing
	Mechanical conditions	class 2M2
Standards	Degree of protection	IP60 to EN 60 529
	Pollution class	II (EN 60 730-1)
	Safety class:	III (IEC 60536)
	Overvoltage category	II (EN 60 730-1)
General	Material	Flame retardant PC+ABS plastic (UL94 class V-0)
	Dimensions (H x W x D)	47 x 98 x 68 mm (1.9 x 3.9 x 2.7 in)
	Transmitter case	
	Weight (including package)	275g (9.6 oz)

Technical specification communication for -MOD types

Network	Hardware interface	RS485 in accordance with EIA/TIA 485
	Max nodes per network	128
	Max nodes per segment	64 (Vector devices only)
	Conductors	Shielded Twisted Pair (STP) cable
	Impedance	100 - 130 ohm
	Nominal capacitance	100 pF/m (16 pF/ft.) or lower
	Galvanic isolation	The communication circuitry is not isolated Connect earth signal of the devices with one another
	Line termination	A line termination resistance (120 ohm) shall be connected between the terminals (+) and (-) of the furthestmost node of the network
	Network topology	Daisy chain according EIA/TIA 485 specifications
	Recommended maximum length per chain	1200 m (4000 ft.)
Modbus (-MOD)	Communication standard	Modbus (www.modbus.org)
	Default setting	19200 baud rate, RTU 8 data bits, 1 even parity bit, 1 stop bit
	Communication speed	4800, 9600, 19200, 38400
	Protocol: Data bits	RTU - 8 data bits, ASCII - 7 data bits, Parity - stop bit

Product Testing and Certification



Declaration of
Conformity

Information on the conformity of our products can be found on our website
www.vectorcontrols.com on the corresponding product page under "Downloads".

Dimensions, mm (inch)

SDC-HTC-MOD with duct probe

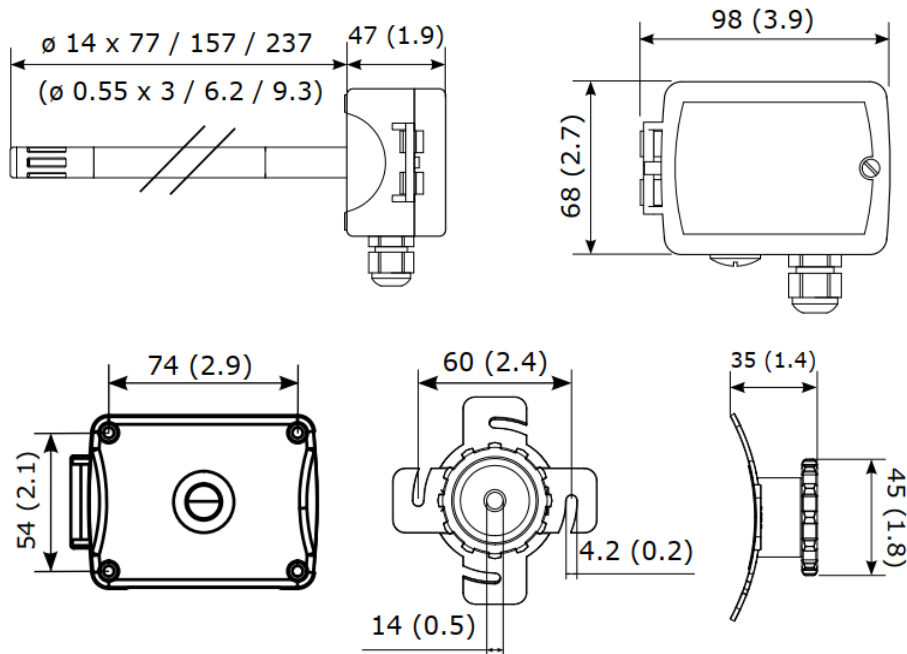

Documentation overview

Document Type	Document No.	Description
SDC-HTC-MOD Data Sheet	70-00-1147	Product data sheet (this document)
SDC-HT-MOD Install Sheet	70-00-1145	Mounting and installation sheet SDC
SOC-HT-MOD Install Sheet	70-00-1146	Mounting and installation sheet SOC
OPA-S Operation Manual	70-00-0171	Operations instructions for external operation terminal OPA-S
OPU-S Short Instruction	70-00-0303	Short instructions for external operation terminal OPU-S (US version)

Note: The above list is not complete. The documents on the website are relevant.

Mounting and Installation

Mounting instructions



For details see "SDC-HTC-MOD" install sheet, document no. 70-00-1145 on our webpage www.vectorcontrols.com

Connection diagram

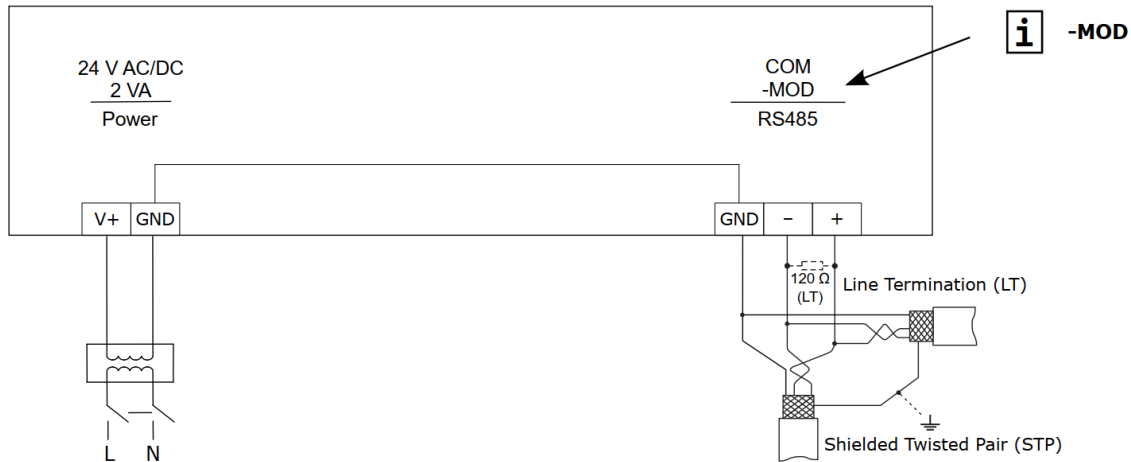

Connection overview

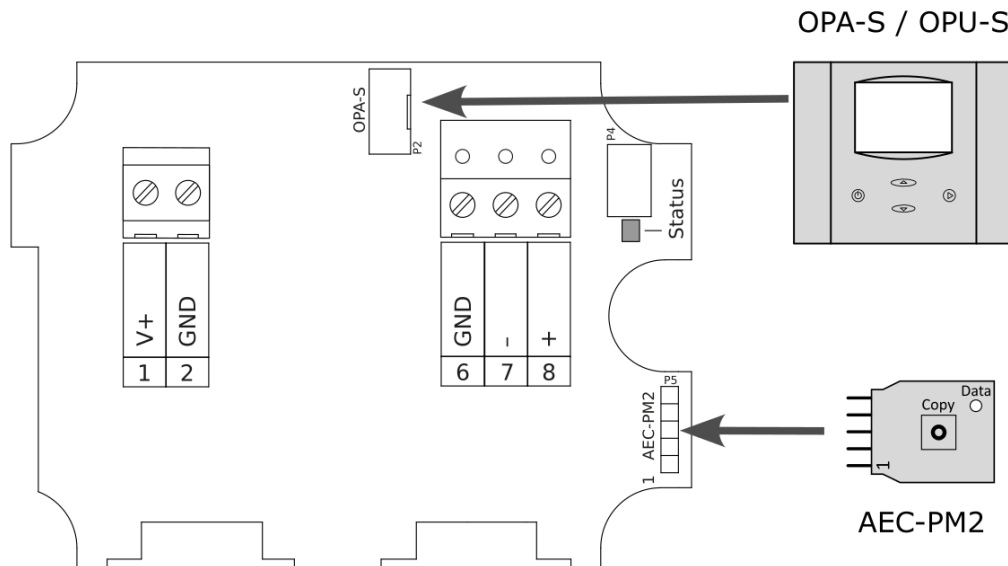

1	V+	Power supply:	24 VAC ±10% 50-60 Hz, 15-34 VDC
2	GND	Power supply:	0 VAC, 0 VDC – common ground
6	GND	COM GND (-MOD):	Modbus Ground (RS485) – common ground
7	-	COM data (-MOD):	Modbus data signal (RS485)
8	+	COM data (-MOD):	Modbus data signal (RS485)

LED-indicator

A status LED is located inside of the transmitter housing. During normal operation the LED will flash once every 5 seconds. If there is an alarm or fault condition, it will flash every second and if an operation terminal is connected an error message will be displayed.



For details see section "Error messages" on page 6.

Operation and Configuration

The SDC-HTC-MOD is designed to work for most applications. However, it can be fine-tuned to fit the application perfectly. To configure the SDC transmitter or to access the minimum and maximum settings, either the optional built-in SDC operation terminal (OPC-S), a remote operation terminal (OPA-S or OPU-S) or Modbus communication (-MOD) must be used. It is also possible to load settings to a memory plug-in accessory (AEC-PM2) and to copy them back to other SDC-HTC-MOD.



For details how to connect see "SDC-HTC-MOD" install sheet, document no. 70-00-1145 on our webpage www.vectorcontrols.com

Operation terminal

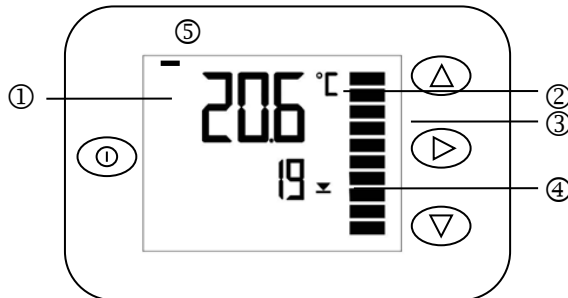

Button Symbol	Function	Description
①	LEFT key	Exit from parameter menu
△	UP key	Display Maximum values, press for more than 3 seconds resets Maximum value
▽	DOWN key	Display Minimum values, press for more than 3 seconds resets Minimum value
▷	RIGHT key	Select transmitter, for transmitters with more than one input.

LCD Display

Position	Description
1	Big 4-digit display of current value, Minimum, Maximum or control parameter
2	Unit of displayed value, °C, °F, % or none
3	Graphical display of output or input signal with a resolution of 10%
4	Small 4-digit display of current value or control parameter
5	Left bar = display of minimum value Right bar = display of maximum value

Error messages

Following error condition may be displayed:

- Err1:** Communication time out between terminal unit and transmitter. Terminal unit will reset after 10 seconds.
- Err2:** Temperature sensor faulty. The connection to the temperature sensor may be interrupted or the temperature sensor is damaged.
- Err3:** Humidity sensor faulty. The connection to the humidity sensor may be interrupted or the humidity sensor is damaged.
- Err4:** CO2 sensor faulty. The connection to the CO2 sensor may be interrupted or the CO2 sensor is damaged.

Display and reset of minimum and maximum values

Press UP key to display maximum values, press DOWN key to display minimum values. To reset the minimum or maximum values press either the UP or DOWN key for more than 3 seconds while the minimum or maximum value is displayed.

Setting the parameters

The parameters are password protected. The parameters can be modified as follows:

1. Press the UP and DOWN buttons simultaneously for 3 seconds. The display shows CODE.
2. Select a password with the UP or DOWN keys. Dial **009** in order to get access to the configuration parameters. After selecting the correct password, press the RIGHT button.
3. Once logged in, use the UP or DOWN keys to select IP for input configuration or OP for output configuration. Once selected, press the RIGHT key.
4. The parameters will now be displayed. The small digits indicate the parameter number and the large digits indicate the parameter value.
5. Select the parameters using the UP/DOWN keys. Modify a parameter by pressing the RIGHT button. The MIN and MAX symbols are displayed to indicate that the parameter can now be changed. Use the UP and DOWN keys to adjust the value.
6. When finished, press the RIGHT or LEFT key in order to return to the parameter selection level.
7. Press the LEFT key again to exit the menu. The unit will return to normal operation if no key is pressed for more than 5 minutes.

Copy parameters to other SDC-HTC-MOD devices

Complete parameter sets can be copied to other SDC-HTC-MOD devices using the AEC-PM2 plug-in memory accessory.

▲ Loading parameters from SDC-HTC-MOD to AEC-PM2

1. Connect the AEC-PM2 plug-in memory to the master SDC
2. Login to the SDC using the operation terminal or Modbus communication
3. Copy the parameters to AEC-PM2
 - a. Set parameter IP 11 to 1 to start copying parameters to the AEC-PM2
 - b. Set parameter IP11 to 2 to start copying parameters to AEC-PM2 with auto address increment
4. The "Data" LED of the AEC-PM2 will light up for 5 seconds if the parameter copy is successful and OP05 is set to 0. If the parameter copy fails, the LED will flash for 5 seconds and IP11 will be set to 7!

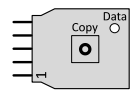

AEC-PM2

▲ Copying parameters from AEC-PM2 to SDC-HTC-MOD

1. Connect the AEC-PM2 plug-in memory to the other SDC
2. Press the "Copy" button on the AEC-PM2
3. The "Data" LED on the AEC-PM2 will light for 5 seconds if the parameters have been successfully copied.
If the parameter copy fails, the LED will flash for 5 seconds!
4. When auto increment is set: The Modbus device address is incremented and the new address is written back to AEC-PM2

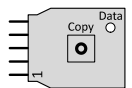

Push to copy configuration

Sensor

Accuracy Humidity sensor

AES4-HT-A3 standard sensor

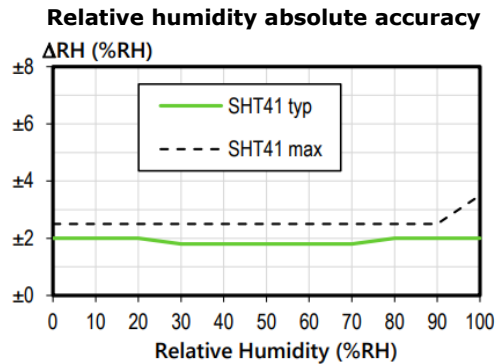

Figure 1: Typical and maximal RH accuracy at 25°C (77°F)

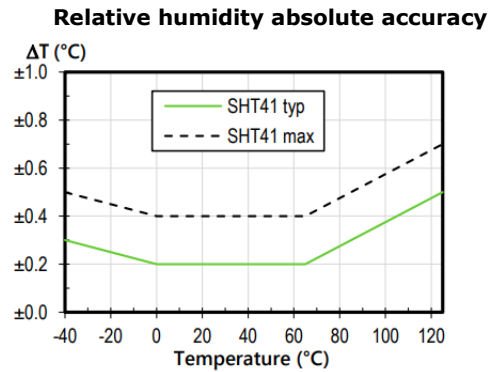

Figure 2: Typical and maximal temperature accuracy

Anti-creep function for devices with AES4 sensors

Ensuring high accuracy of humidity measurement. When the AES4 sensor is exposed to high humidity environments for extended periods of time, an anti-creep function is activated in the background to ensure that the sensing element remains accurate. While the anti-creep function is active, the RH value will appear to be frozen for short periods of time.

Sensor reconditioning function

Reconditioning the humidity sensing element eliminates chemical contamination and creep effects on the sensor and ensures that it operates at its specified accuracy.

Reconditioning can be configured to run once, periodically, or only at power-up.

Parameter **IP08** allows for sensor reconditioning of AES4 sensors.

Per default the value of this parameter is 0. If a number is entered the reconditioning procedure is started:

- The sensor is reconditioned for the number of minutes entered in **IP08**. During this time the status LED blinks in 1 second rhythm.
- If no interval is defined with **IP09**, the number in **IP08** is set to 0, once the recondition has started.
- If an interval is set with **IP09**, the value remains unchanged. When the internal counter reaches 0, reconditioning stops. The interval in hours defined in **IP09** determines the waiting time for the next reconditioning. The interval is stopped during a power failure and resumed when power is restored.

Parameter **IP10** allows reconditioning at each power-up. This reconditioning interval is independent of **IP08** or **IP09** settings. At each power up, the sensor will perform the reconditioning function according to the time in minutes defined with **IP10**.



Recommendation

We recommend to set the **IP08** value to **80** minutes recondition time if the sensor is out of its accuracy range.



Note

The display will freeze during reconditioning.



Important

Reconditioning will not continue if interrupted by a power cycle!

Configuration Parameters

The transmitter can be perfectly adapted to the application. Its parameters are set using the built-in operation terminal OPC-S or the external operation terminals OPA-S / OPU-S. In order to use all the functions described below and get a correct display, only OPA-S or OPU-S units with firmware version V1.5 or higher should be used.

Input configuration

Parameter	Description	Range	Standard
<i>Temperature parameter</i>			
IP 00	TI1: Celsius or Fahrenheit, C = OFF, F = ON	ON, OFF	OFF
IP 01	TI1: Samples taken for averaging control signal	1...255	3
IP 02	TI1: Calibration	-10...10	0.0
IP 03	TI1: Temperature of minimum output signal Note: Has no impact for this device type	-40...125°C (257°F)	-40 °C
IP 04	TI1: Temperature of maximum output signal Note: Has no impact for this device type	-40...125°C (257°F)	60°C
<i>Humidity parameter</i>			
IP 05	HI1: Show percent	ON, OFF	ON
IP 06	HI1: Samples taken for averaging control signal	1...255	3
IP 07	HI1: Calibration	-10...10	0.0
IP 08	Duration of the AES4-HT sensor reconditioning. This value will be cleared if periodic reconditioning is not active. It will remain if periodic reconditioning is enabled. 0: Not active	0-240 min	0 (not active)
IP 09	Interval period for AES4-HT sensor reconditioning 0: Periodic reconditioning disabled 1-240: Period reconditioning enabled (repeats every xxx hours)	0-240 hours	0 (not active)
IP 10	Power up reconditioning for AES4-HT sensor. The sensor is reconditioned each time it is power up. Periodic reconditioning settings have no effect. 0: Not active.	0-240 min	0 (not active)
IP 11	AEC-PM2 parameter copy 0: Parameter copy successful; No action 1: Start parameter copy to AEC-PM2 2: Start parameter copy to AEC-PM2 with auto address increment 7: Copy fail (no AEC-PM2 or communication error)	0..2 7 display only	0
IP 12	Modbus communication address	1-247	1
IP 13	Modbus baud rate: 0 = 19200 1 = 4800 2 = 9600 3 = 19200 4 = 38400	0-4	3
IP 14	Modbus communication mode: 0 = Modbus RTU, No parity, 2 stop bits 1 = Modbus RTU, Even parity, 1 stop bit 2 = Modbus RTU, Odd parity, 1 stop bit 3 = Modbus RTU, No parity, 1 stop bit 4 = Modbus ASCII, No parity, 2 stop bits 5 = Modbus ASCII, Even parity, 1 stop bit 6 = Modbus ASCII, Odd parity, 1 stop bit	0-6	1
IP 15	Allow parameter change via Modbus 0 = No change allowed 1 = Change allowed	0-1	1

Note: The parameters for CO2 configuration are available via Modbus only.

Modbus communication with SDC-HTC-MOD

Communication specifications Modbus RTU/ASCII

- RS485 2-wire MODBUS standard in accordance with EIA/TIA 485
- Slave type of communication
- Supports up to 127 nodes on one network
- Selectable transmission types:
 - **RTU** with CRC16 checksum
 - ASCII with LRC checksum
- Baud rates: 4800, 9600, **19200**, 38400
- Parity: No parity, odd or **even parity**.

Default: RTU with 8 data bits, 1 even parity bit, 1 stop bit. Baud rate 19200.

Standards

Communication standard:	Modbus (www.modbus.org)
Default setting:	19200 Baud rate, RTU 8 data bits, 1 even parity bit, 1 stop bit
Communication speed:	4800, 9600, 19200, 38400
Protocol:	Modbus RTU with CRC16 checksum, Modbus ASCII with LRC checksum
Parity – stop bit:	no parity – 2 stop, even parity or odd parity – 1 stop, no parity – 1 stop (RTU mode only)

“No Parity” mode: In these cases, a 2nd stop bit is used to keep the byte length (11bit for RTU and 10 bit for ASCII, including the Start and Stop bits) unchanged in accordance with the Modbus specification. Other possible serial port modes like Odd Parity or baud rates other than listed ones are not supported.

Supported Modbus commands

- 03 (0x03): Read multiple registers
- 06 (0x06): Write single register
- 16 (0x10): Write multiple registers

In commands 03 and 16 the allowed number of registers ranges from 1 to 32. Although Modbus specification would allow more registers to be read and written, a maximum of 32 Modbus registers are supported in one packet. One Modbus register is 16 bits wide. The Modbus slave transmits the values as signed 16 bit integers.

In an event of an out-of-range command addressing or an unsupported command, the Modbus slave responds with an exception message according to the Modbus specification.

Modbus addresses for SDC-HTC-MOD

Table entry description

Address: Modbus address to access information

Access: Specifies how data can be accessed. R: Read only access, R/W: Read and write access

Description: Describes the type of the entry

Multiplier: Multiply the value displayed in Modbus with "Multiplier" to compute the real value

Unit: Unit of this parameter

Sensor values

Address	Access	Description	Range	Multiplier	Unit
0	R	Temperature value	-400-1250	0.1	°C
			-400-2570	0.1	°F
1	R	Minimum temperature value	-400-1250	0.1	°C
			-400-2570	0.1	°F
2	R	Maximum temperature value	-400-1250	0.1	°C
			-400-2570	0.1	°F
3	R/W	Reset minimum and maximum temperature value Write "1" to this register to reset the values.	0-1	1	No unit
4	R	Humidity value	0-1000	0.1	%
5	R	Minimum humidity	0-1000	0.1	%
6	R	Maximum humidity	0-1000	0.1	%
7	R/W	Reset minimum and maximum humidity value Write "1" to this register to reset the values.	0-1	1	No unit
8	R	CO2 value	0-5000	1	ppm
9	R	Minimum CO2 value	0-5000	1	ppm
10	R	Maximum CO2 value	0-5000	1	ppm
11	R/W	Reset minimum and maximum CO2 value Write "1" to this register to reset the values.	0-1	1	No Unit

Calculated values

Address	Access	Description	Range	Multiplier	Unit
50	R	Dew point	-400-1000	0.1	°C
			-400-2120	0.1	°F
51	R	Minimum dew point	-400-1000	0.1	°C
			-400-2120	0.1	°F
52	R	Maximum dew point	-400-1000	0.1	°C
			-400-2120	0.1	°F
53	R/W	Reset minimum and maximum dew point value Write "1" to this register to reset the values.	0-1	1	No unit
54	R	Enthalpy	-32768-32767	0.1	kJ/kg (Btu/lb)
55	R	Minimum Enthalpy	-32768-32767	0.1	kJ/kg (Btu/lb)
56	R	Maximum Enthalpy	-32768-32767	0.1	kJ/kg (Btu/lb)
57	R/W	Reset minimum and maximum enthalpy	0-1	1	No unit
58	R	Mixing ratio	-32768-32767	0.1	g/kg (gr/lb)
59	R	Minimum mixing ratio	-32768-32767	0.1	g/kg (gr/lb)
60	R	Maximum mixing ratio	-32768-32767	0.1	g/kg (gr/lb)
61	R/W	Reset minimum and maximum mixing ratio	0-1	1	No unit
62	R	Absolute humidity	-32768-32767	0.1	g/m ³ (gr/ft ³)
63	R	Minimum absolute humidity	-32768-32767	0.1	g/m ³ (gr/ft ³)
64	R	Maximum absolute humidity	-32768-32767	0.1	g/m ³ (gr/ft ³)
65	R/W	Reset minimum and maximum absolute humidity	0-1	1	No unit
66	R	Wet bulb temperature	-400-1000	0.1	°C
			-400-2120	0.1	°F
67	R	Minimum wet bulb temperature	-400-1000	0.1	°C
			-400-2120	0.1	°F
68	R	Maximum wet bulb temperature	-400-1000	0.1	°C
			-400-2120	0.1	°F
69	R/W	Reset minimum and maximum wet bulb temperature	0-1	1	No unit

General configuration

Address	Access	Description	Range	Multiplier	Unit
150	R	Installation altitude	0-3000	1	masl
			0-9842	1	ftasl

Input configuration

Address	Access	Description	Range	Multiplier	Unit
200	R/W	Unit SI or imperial 0 = SI 1 = Imperial	0-1	1	No unit
201	R/W	Samples taken for averaging temperature input signal	1-255	1	No unit
202	R/W	Temperature sensor calibration	-100-100	0.1	°C
			-180-180	0.1	°F
203	R/W	Minimum temperature	-40-125	1	°C
			-40-257	1	°F
204	R/W	Maximum temperature	-40-125	1	°C
			-40-257	1	°F
205	R/W	Show percentage on OPA-S for humidity	0-1	1	No unit
206	R/W	Samples taken for averaging humidity input signal	1-255	1	No unit
207	R/W	Humidity sensor calibration	-100-100	0.1	%
208	R/W	Duration of the AES4-HT sensor reconditioning. This value will be cleared if periodic reconditioning is not active. It will remain if periodic reconditioning is enabled. 0: Not active	0-240	1	Minutes
209	R/W	Interval period for AES4-HT sensor reconditioning 0: Periodic reconditioning disabled 1-240: Period reconditioning enabled (repeats every xxx hours)	0-240	1	Hours
210	R/W	Power up reconditioning for AES4-HT sensor. The sensor is reconditioned each time it is power up. Periodic reconditioning settings have no effect. 0: Not active.	0-240	1	Minutes
211	R/W	Samples taken for averaging CO2 input signal	1-255	1	No unit
212	R/W	CO2 sensor calibration	-100-100	1	ppm
213	R/W	Minimum CO2 range ppm (CO2 level when output is at its minimum; Only applicable if AO present)	0-5000	1	ppm
214	R/W	Maximum CO2 range ppm (CO2 level when output is at its maximum; Only applicable if AO present)	0-5000	1	ppm
215	R/W	Enable ABC automatic CO2 background calibration	0-1	1	No unit
216	R/W	Calibrate CO2 sensor Note: For normal operation, calibration is not required. Only experts should calibrate the sensor. 0 = No calibration (default) 1 = Calibrate to gas (0 ppm) 2 = Calibrate to fresh air (430 ppm) 4 = Calibrate error (status, read only)	0-2, 4 (read only)	1	No unit

Device information

Address	Access	Description	Range	Multiplier	Unit
400	R	Software version	-	1	No unit
401	R	Software revision	-	1	No unit
402	R	Device ID	-	1	No unit
403	R	Error	1-7	1	No unit
404	R	Alarm	1-7	1	No unit
405	R/W	AEC-PM2 copy (Range 0..1, 7 read only) 0: Parameter copy successful; No action 1: Start parameter copy to AEC-PM2 2: Start parameter copy to AEC-PM2 with auto address increment 7: Copy fail (no AEC-PM2 or communication error)	0-2 7 Read only	1	No unit

Modbus configuration

Address	Access	Description	Range	Multiplier	Unit
500	R/W	Modbus device address	1 -247	1	No unit
501	R/W	Baud rate Modbus RS485 0 = 19200 1 = 4800 2 = 9600 3 = 19200 4 = 38400	0-4	1	No unit
502	R/W	Communication mode 0 = Modbus RTU, No parity, 2 stop bits 1 = Modbus RTU, Even parity, 1 stop bit 2 = Modbus RTU, Odd parity, 1 stop bit 3 = Modbus RTU, No parity, 1 stop bit 4 = Modbus ASCII, No parity, 2 stop bits 5 = Modbus ASCII, Even parity, 1 stop bit 6 = Modbus ASCII, Odd parity, 1 stop bit	0-6	1	No unit
503	R/W	Allow parameter change through Modbus 0 = No change allowed 1 = Parameter change allowed 37 = Parameter change allowed including OE (expert only)	0-1 37 (expert only)	1	No unit

Note: Default value are bold

OE parameters (expert only)

Address	Access	Description	Range	Multiplier	Unit
1000	R	Not used	0-255	1	No unit
1001	R	Not used	0-255	1	No unit
1002	R	OPA-S software version	0-255	1	No unit
1003	R	SDC software version	0-255	1	No unit
1004	R	Not used	0-255	1	No unit
1005	R	Not used	0-255	1	No unit
1006	R	Not used	0-255	1	No unit
1007	R/W	Enable humidity sensor anti creep function 0 = OFF, 1 = ON	0-1	1	No unit

Smart Sensors and Controls Made Easy!

Quality - Innovation – Partnership

Vector Controls GmbH
Switzerland

info@vectorcontrols.com

www.vectorcontrols.com

