



OPF2-2T-VC, OPF2-2TH-VC

Wall mount operation terminal for X2 controllers and sensors

The OPF2-2T-VC, OPF2-2TH-VC is a wall-mountable remote display and operation terminal for the X2 controllers and sensors and includes a temperature and humidity sensor as well as two passive inputs. The large backlit display allows easy configuration of the parameters and operation of the controller.

Functions

- Remote access to controller state, setpoints, inputs and outputs
- Access to time schedule and clock settings
- Access to configuration parameters
- RS485 peer to peer communication to a X2 controller over a proprietary protocol
- The terminal adapts itself to the X2 controller used. One terminal thus fits all the configuration variations of the X2 product range.
- 1 Internal temperature sensor
- 1 Internal humidity sensor with AES4-HT-A3
- 2 passive inputs for open contacts or temperature measurement

Applications

- Configuration and operation of X2 controllers and sensors
- Remote supervision (RS485)

Safety



DANGER! Safety advice

This device is for use as operating controls. It is not a safety device! Where a device failure endangers human life and/or property, it is the responsibility of the client, installer and system designer to add additional safety devices to prevent a system failure caused by such a device failure. Ignoring specifications and local regulations may cause equipment damage and endangers life and property. Tampering with the device and misapplication will void warranty.

Types and Ordering

Product Name	Product No.	Description
OPF2-2TH-VC	40-50-0158	Wall mount operation terminal for X2 controllers with peer-to-peer RS485 communication: 1 internal temperature sensor, 1 internal humidity sensor and 2 passive inputs
OPF2-2T-VC	40-50-0159	Wall mount operation terminal for X2 controllers with peer-to-peer RS485 communication: 1 internal temperature sensor and 2 passive inputs
<i>Accessories</i>		
AES4-HT-A2	40-50-0153	Sensor element accuracy RH ± 2 %, temperature ± 0.3 °C
AES4-HT-A3	40-50-0152	Sensor element accuracy RH ± 3 %, temperature ± 0.4 °C

Technical specifications

Power supply	Power requirements	5...24 V AC/DC ±10%, 50/60 Hz, 5...34 VDC SELV to HD 384, Class II, 48VA max	
	Power consumption	Max. 1 VA, max 0.5W	
	Electrical connection	Screw terminal connectors for wire 0.13...2.0 mm ² (AWG 26...14)	
Built in sensors (Type)	Temperature sensor	NTC 10kΩ @ 25 °C (77 °F)	
	Range	0...50 °C (32...122 °F)	
	Measuring accuracy	0.5 C (0.9 F)	
	-TH	Humidity sensor	Capacity sensor element
		Range	0...100% RH
		Measuring accuracy	See Figure 1 in section Sensors
		Hysteresis	± 1%
Repeatability	± 0.1%		
Stability	< 0.2% / year		
Signal Input	Passive input RT/DI Type	IN1, IN2 NTC 10kΩ@25 °C (77 °F) or open contact to GND	
Communication	Hardware interface	RS485 in accordance with EIA/TIA 485	
	Cabling	Shielded twisted pair (STP) cable	
	Impedance	100 to 130 ohm	
	Nominal capacitance	100 pF/m (30 pF/ft) or lower	
Environment	Operation	To IEC 721-3-3	
	Climatic conditions	class 3K5	
	Temperature	0...50 °C (32...122 °F)	
	Humidity	<85 % RH non-condensing	
	Transport & storage	To IEC 721-3-2 and IEC 721-3-1	
	Climatic conditions	class 3K3 and class 1K3	
	Temperature	0...50 °C (32...122 °F)	
Humidity	<95 % RH non-condensing		
	Mechanical conditions	class 2M2	
Standards	Degree of Protection	IP30 to EN 60 529	
	Pollution Class	II (EN 60 730-1)	
	Safety Class	III (EN 60 730-1)	
	Overvoltage Category	II (EN 60 730-1)	
General	Material	Flame retardant PC+ABS plastic (UL94 class V-0)	
	Dimensions (H x W x D)	93 x 93 x 25 mm (3.7 x 3.7 x 0.95 in)	
	Weight (including package)	198g (7.0 oz)	

Product testing and certification



Declaration of conformity

Information on the conformity of our products can be found on our website www.vectorcontrols.com on the corresponding product page under "Downloads".

Mounting and Installation

Mounting location

- Mount the operation terminal on an easily accessible interior wall, approx. 1.5 m above the floor in an area of average temperature.
- The following mounting locations should be avoided:
 - Protect from direct exposure to sunlight
 - Do not mount near heat sources or other heat-generating devices
 - Do not mount in a wet or condensation prone environment
 - Areas with poor air circulation and niches or behind doors
 - In the direct influence area of ventilation and fans



Important

Observe local regulations!

Sealing of cable entries



Important

All cable entries into the operation terminal must be sealed to prevent air drafts, which could otherwise affect the sensors in the device and prevent correct measurements!

Installation instructions



See the OPF2-VC installation sheet, document no. 70-00-1019 (www.vectorcontrols.com).

Wiring and Connection



WARNING! Live Electrical Components

During installation, testing, servicing and troubleshooting of Vector Controls products, it may be necessary to work with live electrical components. Have a qualified licensed electrician or other individual who has been properly trained in handling live electrical components perform these tasks. Failure to follow all electrical safety precautions when exposed to live electrical components could result in death or serious injury

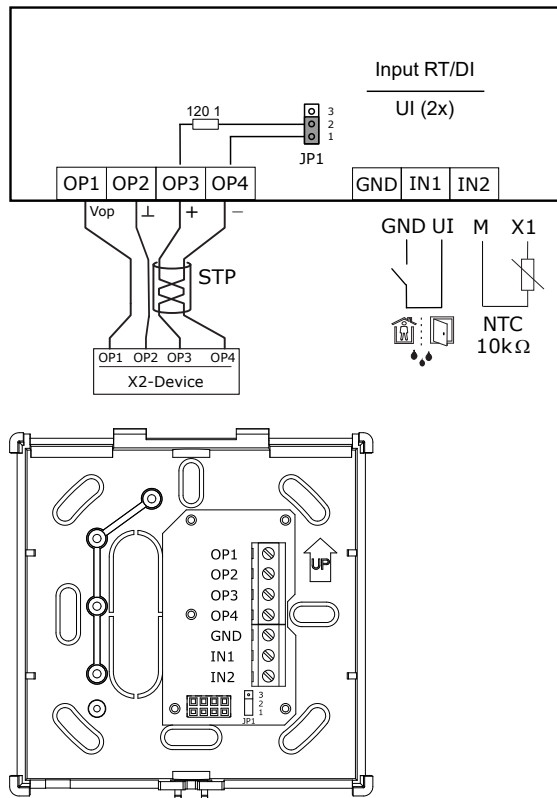

OP1	Communication X2:	V+ power supply (RS485)
OP2	Communication X2:	0V power supply (RS485)
OP3	Communication X2:	RS485+
OP4	Communication X2:	RS485-
GND	External input ground:	0V, Common for inputs
IN1	External input signal:	Passive input, Temperature NTC 10kΩ @ 25 °C (77°F)
IN2		or open contact to GND

Wiring of communication (RS485)

Wire type

An EIA-485 network shall use shielded, twisted-pair cable for data signaling with characteristic impedance between 100 and 130 ohms. Distributed capacitance between conductors shall be less than 100 pF per meter (30 pF per foot). Distributed capacitance between conductors and shield shall be less than 200 pF per meter (60 pF per foot). Foil or braided shields are acceptable.

Maximum length

The maximum recommended length per segment is 1200 meters (4000 feet) with AWG 18 (0.82 mm² conductor area) cable.

Network terminating resistor

The built-in 120 Ohm network termination resistor is enabled by default with jumper JP1 in positions 1 and 2.

Dimensions, mm (inch)

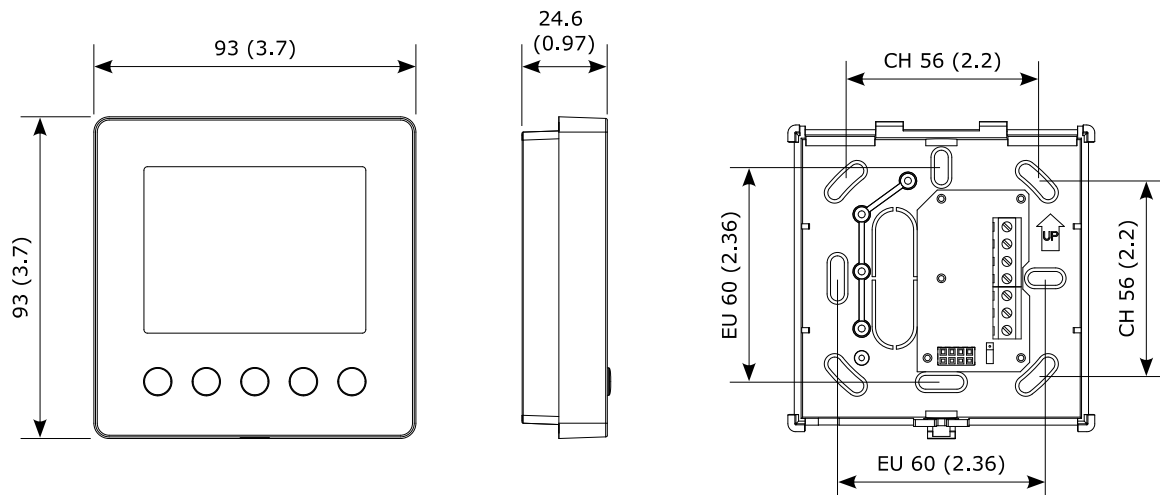

Documentation overview

Document Type	Document No.	Description
OPF2-VC Data Sheet	70-00-1020	Product data sheet (this document)
OPF2-VC Install Sheet	70-00-1019	Mounting and installation manual

Sensors

Humidity from RH sensor in -TH type

For measuring humidity, this device uses the sensor plug-in AES4-HT-A3.

Accuracy of relative humidity sensor (RH)

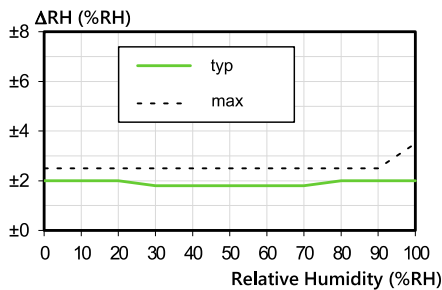
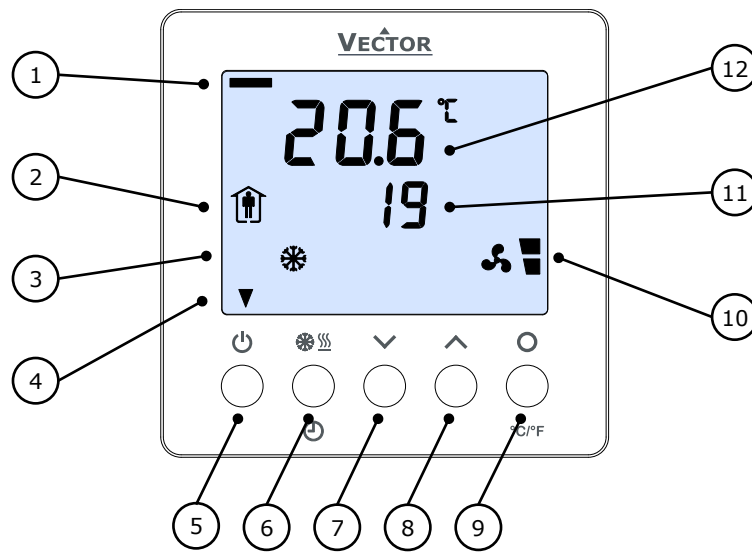



Figure 1: Typical and maximal RH-Accuracy at 25°C (77°F)

Display and Operation







Pos.	Function / Description
1	Loop indication - Standard display (no button pressed for 30 sec.): Not visible - Loop display: Bar at far left = Loop 1, Bar toward right = Loop 2
2	Operating Mode - Display of operation mode
3	Controlling Mode - Display of control mode
4	Indicators - Standard display: Active digital outputs (arrow at far left=1, toward right=2)
5	Operating Mode (POWER)(Back) - Press < 2 sec.: Toggle OCCUPIED / UNOCCUPIED mode or switch from OFF to ON - Press > 2 sec.: Turn unit OFF. Text OFF displayed - (Parameter setting: BACK to previous menu) - (Menu navigation: Back to previous/home menu)
6	OPTION - Press < 2 sec.: Toggle HEATING / COOLING - Press > 2 sec.: Enter set-up CLOCK ...
7	DOWN (-) - Decrease SET POINT - (Parameter setting: SCROLL menu options and parameters)
8	UP (+) - Increase SET POINT - (Parameter setting: SCROLL menu options and parameters)
9	RIGHT °C/°F (Enter) - Press < 2 sec.: Select Fan speed, Control Loop - Press > 2 sec.: Change °C / °F - (Parameter setting: select UI calibration in UI menu) - (Parameter setting: ENTER to select menu option, accept parameter change)
10	Vertical Bar - Display of input/output value with 10% resolution - (Parameter setting: Displays programming step)
11	Small Digits - Display of setpoint, clock or parameter number
12	Large Digits - Display of measured room temperature, input or parameter value

Operating mode

Display	Description
	Occupied (Comfort) - All control functions operating per set points
	Unoccupied (Economy) - Set points shifted according to 1L07, 2L07
OFF	Protection (Energy Hold Off) - Outputs are off, inputs monitored for alarms

Controlling mode

Display	Description
	Cooling - Cooling (Direct) Active
	Heating - Heating (Reverse) Active
	Manual - Manual Override
	Clock / Schedules - Schedule Set
	Fan - Fan Active

Operation status

Display	Description
	Alarm - Alarm active

Idle display

- The idle display is activated when no key has been pressed for 30 seconds.
- The contents of the idle display are selectable through parameters UP08 to UP14.
- Setting UP08 to OFF will disable idle display. Last active control loop or manual output will remain displayed.

Display of control loop

- Active when changing set points. Large digits show input value. Small digits show set point. Horizontal bars top left show which loop is being displayed.

Operation instructions

For operation details for the OPF2-2TH-VC see "X2-Operation Manual Button Display", document no. 70-00-0950 (www.vectorcontrols.com).

Empty page.

Smart Sensors and Controls Made Easy!

Quality - Innovation – Partnership

Vector Controls GmbH
Switzerland

info@vectorcontrols.com
www.vectorcontrols.com

