

MZ3-C-FS-V11 Controller/positioner for comfort ventilation with integrated CO2 sensor

Function

- Positioner and controller for comfort ventilation with touch panel
- Internal CO2 sensor for air quality measurement
- Manual operation with up to 4 Levels, OFF, minimum air, 1st Level, 2nd Level, maximum air
- AUTO level mode: The controller switches the ventilation according to adjustable levels of the CO2 sensor value.
- AUTO continuous mode: The controller adjusts the ventilation level gradually between adjustable minimum and maximum according to CO2 sensor value
- One 0...10 VDC controls output to control the ventilation system
- Automatic reset of the maximum air level (standard: level 0 after 120 min.)
- Password protected controls settings
- Copy of settings with accessory (AEC-PM2)
- Design fits to the Feller SNAPFIX® program with the design lines EDIZIOdue® and EDIZIO.liv®.
(Note: SNAPFIX® mounting plate and EDIZIO design frames are not included and must be ordered separately)



Applications

This device is designed to control ventilation systems for comfort applications. For example, for well insulated residential areas which are required to be ventilated or for controlling dampers, valve drives, blinds or windows, etc.

General description

The MZ3-C-FS-V11 is a microprocessor-controlled precision positioner / proportional controller with touch panel. Through user and engineering parameters the positioner may be configured to work for most of the standard ventilation applications. The device is pre-configured according to this documentation. Settings such as switching levels of the control curve and ventilation strengths for each Level may be adjusted. The configuration may be performed using the programming device called OPA-S. This device may be used as well to visualize measuring values. Configuration can as well be updated using a remote memory device called AEC-PM2.

CO2 sensor

The CO2 concentration is measured by photoacoustic sensor technology PASens® with automatic background calibration algorithm (ASC). The measurement technology used guarantees high reliability and long-term stability. The sensor has a pressure dependence (atmospheric pressure), therefore the altitude above sea level can be optionally adjusted to achieve even better accuracy. The microprocessor measures the CO2 concentration every 5 seconds and calculates the signal value from a number of measured values.

Error indication

In case of a sensor error, the failed state is indicated with the OPA-S and the "CO2" LED. In "auto" operation the "CO2" LED blinks in 1Hz cycle to indicate the error. Additionally, "Err3" is shown on OPA-S when plugged in.

Automatic CO2 background calibration (ASC)

Background Calibration (ASC) is turned on by default and constantly monitors the measured CO2 concentrations. The calibration function expects the CO2 concentration to periodically drop to fresh air levels of 400 ppm. Over a period of several days, the controller attempts to gradually reach this value by recalibrating a maximum of 30ppm per day. To achieve the specified accuracy, it is necessary for the sensor to run continuously without power interruption for at least 3 weeks.

For special applications such as greenhouses, animal farms, etc., ASC calibration should be disabled and the sensor calibrated manually. The automatic calibration ASC can be deactivated via the external operating terminal OPA-S. The sensor can be calibrated by the customer and does not have to be sent in for calibration.



For more information on manual calibration, see section "Calibration" page 7.

Safety



DANGER! Safety note

This device serves as an actuator or proportional controller for ventilation systems. Where a control failure would result in personal injury and/or property damage, it is the responsibility of the customer, designer and installer to install additional equipment and devices that will prevent a control failure or warn if limits are exceeded.

The device contains electronic components and must not be disposed of with household waste.

Types and ordering

Product name	Product No.	Description	Features
MZ3-C-FS-V11-B-T4-W	40-100300	- CO2 sensor - Blue LED - White background - Minimum, Normal, Maximum, Party	Compact positioner / controller with CO2 sensor and one 0-10 VDC output. Operation as 4-Level switch with touch panel and AUTO function.

Note: Mounting plate and frame are not included. See below for options.

Accessories

AMM-DS-W	40-510104	Feller EDIZIOdue® frame white	Includes SNAPFIX® mounting plate
AMM-LS-W	40-510105	Feller EDIZIO.liv® frame white	Includes SNAPFIX® mounting plate
OPA-S	40-500006	Programming and display device	LCD display for surface mounting or handheld operation.
AEC-PM2	40-500130	Memory-Device. Used for copying settings	Stores settings of MZ3

Interface to the ventilation system

The positioner works with all systems that are designed for a 0...10 VDC or 2...10 VDC input signal.

Technical Data

Power supply	Operating voltage	24 V AC/DC ± 10%, 50/60 Hz, Class 2 48 VA max.
	Power consumption	Max. 1 VA
	Electrical connection	Terminal connectors, wire 0,34-2,5 mm ² (AWG 22...13)
Internal sensors	CO2 sensor	Photoacoustic sensor technology PASens® with automatic calibration in the background (ASC)
	Response time (63%)	1 minute
	Measuring range	0 - 2000 ppm vol.
	Repeatability	± 10 ppm typical
	Accuracy	± 50 ppm + 5% of measured value
Signal output	Analog output	
	Output signal	DC 0...10 V
	Maximum load	2 mA or 5 kΩ
Environment	Operation	To IEC 721-3-3
	Climatic conditions	class 3K5
	Temperature	0...50 °C (32...122 °F)
	Humidity	< 95% RH non-condensing
	Transport & storage	To IEC 721-3-2 and IEC 721-3-1
	Climatic conditions	class 3K3 and class 1K3
	Temperature	0...50 °C (32...122 °F)
	Humidity	< 95% RH non-condensing
	Mechanical conditions	class 2MT2
Standards	Degree of protection	Wall mounted: IP40 acc. EN 60529 Not installed: IP00 acc. EN 60529
	Safety class	III (IEC 60536)
General	Housing material:	Flame retardant PC+ABS plastic (UL94 class V-0)
	Dimensions (H x W x D) including packaging	60 x 60 x 40 mm (2.4" x 2.4" x 1.6")
	Weight (incl. packaging)	90 g (3.2 oz)

Product testing and certification



Declaration of Conformity

Information on the conformity of our products can be found on our website www.vectorcontrols.com on the corresponding product page under "Downloads".

Connection diagram

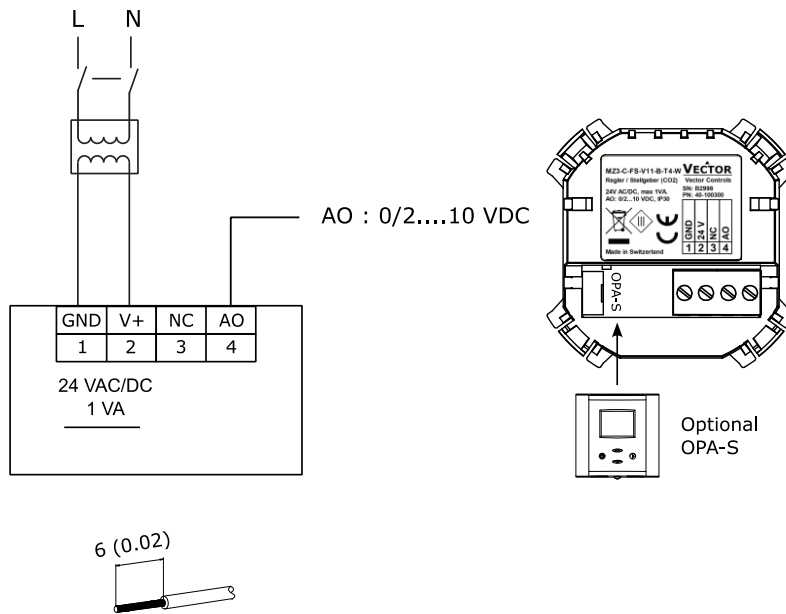

Description:

- 1 GND** Power supply: 0 V, -24 VDC, internally connected to signal common
- 2 V+** Power supply: 24 VAC, +24 VDC
- 3 NC** No connection
- 4 AO** Analog output ventilation: 0/2...10 VDC

Mounting instruction



Important

All cable entries into the connection box must be sealed to prevent air drafts, which could otherwise affect the sensors in the device and prevent correct measurements!



For more information on mounting, refer to MZ3-C-FS-V11 Installation Manual No. 70-001095 (www.vectorcontrols.com).

Dimensions mm (in)

The MZ3-C-FS-V11 is so designed that it can be incorporated into a commercially available flush box (Feller EDIZIOdue® frame and mounting plate are included).

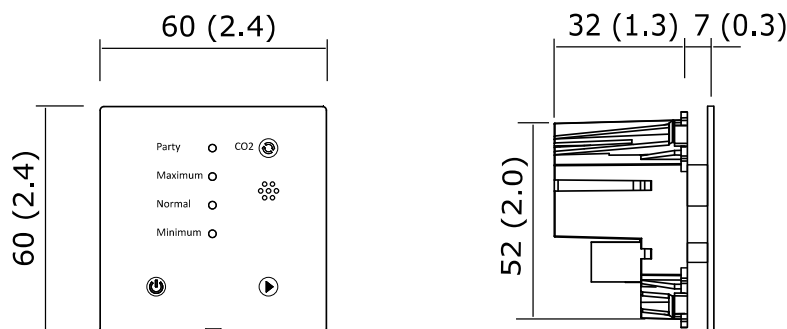

Display and Operation

ON/OFF operation

The device is activated by pressing the ON/OFF button. Depending on the position of JP1, the minimum air volume remains active even during OFF mode. In OFF mode, the operating mode symbol lights up with reduced intensity.

Manual operation

The following operation modes will be activated through repeated pressing of the level button:

- Level 0 = Minimum volume [Minimum]
- Level 1 = Normal volume [Normal]
- Level 2 = High volume [Maximum]
- Level 3 = Maximal volume [Party]
- Auto operation (automatic level selection)

The active level is activated after 3 seconds. This prevents unnecessary switching when setting the device. The level-indication and buttons light up in green or blue depending on the type of device.

The device is equipped with proximity detection. When approaching a distance of approx. 10 cm, the luminosity of the LED increases. After 30 seconds without interaction, the LEDs dim down again and thus save energy.

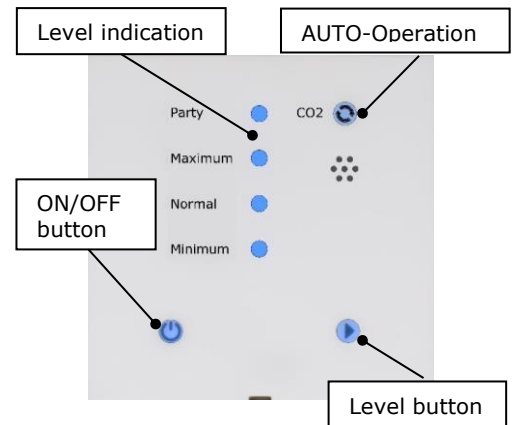

Operating Modes

Manual operation

In manual mode, the ventilation level is defined by means of the level button, see section „Display and Operation“ on page 4.

Automatic operation

Automatic operation must be activated with the level button or through the automatic reset function defined with IP08, see section “Display and Operation” on page 4 and “Input configuration (CO2)” on page 6.

IP08 defines a reset time after which the unit returns to automatic mode if it has been manually overridden. With a reset time setting of 0, automatic reset is deactivated.

Level mode (IP00=ON)

During AUTO operation, the levels are switched by a control signal. The switching levels are defined under IP04 – IP06. The hysteresis defined with IP07 prevents rapid switching of levels in auto mode.

Function: A level activates once the input signal exceeds the activation limit (IP04-IP06). It deactivates once the input signal drops below the activation limit minus the hysteresis. For example, with a hysteresis of 10% and an activation limit of 40%, the level activates with a 40% input signal and switches down to the next lower level with a 30% input signal.

Automatic switching for certain levels may be disabled by setting an activation limit of 0. The sensor signal will then not be able to activate this particular level. This may be useful for the highest level (boost mode) by setting IP06 = 0.

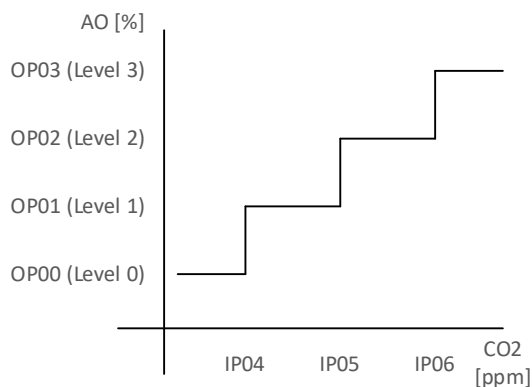

Figure 1: Function level mode

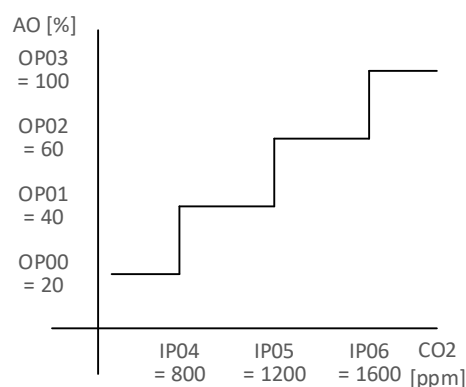

Figure 2: Example level mode

Continuous mode (IP00=OFF)

During AUTO operation, the ventilation is controlled gradually by the sensor signal. Instead of level steps, the output voltage is adjusted continuously. The sensor minimum and sensor maximum of the linear range can be set with IP04 and IP06. The output voltage then behaves linearly between OP00 and OP03.

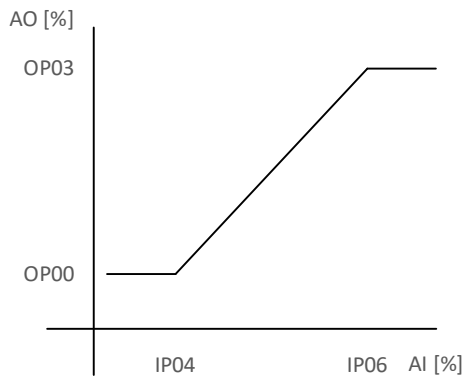

Figure 3: Function continuous mode

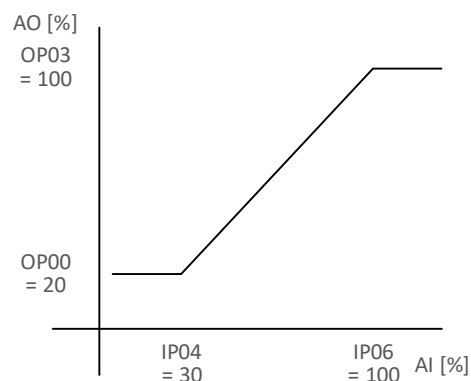

Figure 4: Example continuous mode

i NOTE: If the MZ3 is used in continuous mode, the following settings are recommended:

- IP04 = 20% (400 ppm)
- IP06 = 100% (2000 ppm)
- OP00 = 0% (0 V)
- OP03 = 100% (10 V)

Configuration

Configuration of the output signal and jumper

- If JP1 is in position 1-2, the output signal is 0 VDC in OFF mode
- If JP1 is in position 2-3, the output signal remains at level 0 (minimum volume) in OFF mode according to OP00

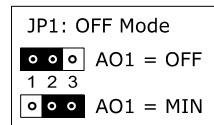

Setting the parameters

The MZ3 is designed to work for most comfort ventilation applications. It is however possible to fine tune it to fit perfect into the application at hand. The parameters can be changed during operation through an operation unit called OPA-S. The operating unit OPA-S must be connected for the adjustment of the parameters with the MZ3 at the connector under the front panel or on the back of the MZ3.

Carefully lift the front panel of the MZ3 and pull it away to the front. Plug the connecting cable of the OPA-S operating unit into the rear part of the MZ3.

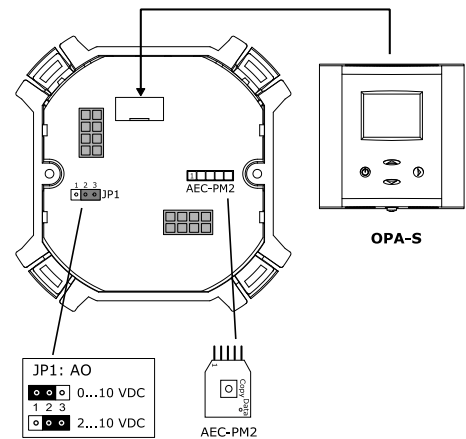

! **Important**
The MZ3 does not accept the new settings until the OPA-S parameter menu is exited. The connection must not be disconnected earlier than five seconds after the last keystroke!

Input configuration (CO2)

Parameter	Description	Range	Default
IP00	Auto operation - ON: Level mode: Output jumps to the defined level depending on the input values in: OP00, OP01, OP02 or OP03 - OFF: Continuous mode: Output behaves linear between OP00 and OP03 in Auto mode.	ON, OFF	ON
IP01	Samples taken for averaging input signal	1...255	3
IP02	400 ppm Calibration - 0: Normal, not active - 1: Start 400 ppm calibration - 7: Calibration failed	0...1 7: display only	0
IP03 ¹⁾	Automatic Self-Calibration (ASC) - ON: ASC switched on - OFF: ASC switched off	ON, OFF	ON
IP04	- Level mode: CO2 switching limit of level 1. - Continuous mode: CO2 start value for continuous control for the minimum output voltage according to OP00	400...2000 ppm	800 ppm
IP05	- Level mode: CO2 switching limit of level 2. Note: If this level is set to 0, it is deactivated for level mode. ²⁾ - Continuous mode: Not used. ³⁾	400...2000 ppm	1200 ppm
IP06	- Level mode: CO2 switching limit of level 3. Note: If this level is set to 0, it is deactivated for level mode. ²⁾ - Continuous mode: CO2 end value for continuous control for the maximum output voltage according to OP03	400...2000 ppm	1600 ppm
IP07	CO2 hysteresis of level mode	0...2000 ppm	200 ppm
IP08	Reset time manual to auto operation 0: Never reset	0...255 min	0 min
IP09	Altitude (meters above sea level) for pressure compensation of the CO2 sensor	0...5000 m	400 m

¹⁾ If IP03 = Off, a manual 400 ppm calibration must be performed regularly. Annual drift ± 5 ppm + 2 % of measured value.

²⁾ The smallest deactivated level determines up to which level the automatic level mode can regulate.

³⁾ If IP06 = 0, IP05 is the sensor end value for the maximum output voltage according to OP02.

Output configuration (AO)

Parameter	Description	Range	Default
OP00	Output level 0: 0...100 % = 0...10.0 VDC	0...100%	20% = 2 V
OP01	Output level 1: 0...100 % = 0...10.0 VDC Note: setting a level to 0 disables it	0...100%	40% = 4 V
OP02	Output level 2: 0...100 % = 0...10.0 VDC Note: setting a level to 0 disables it	0...100%	60% = 6 V
OP03	Output level 3: 0...100 % = 0...10.0 VDC Note: setting a level to 0 disables it	0...100%	100% = 10 V
OP04	Automatic reset time of the highest level to the level defined in OP05. The reset is deactivated with setting = 0	0...255 min	120 min
OP05	Level after automatic reset. This level will be activated once the reset time defined in OP04 has expired.	0...2	0
OP06	- 0: Parameter copy successful; No action - 1: Start parameter copy to AEC-PM2 - 7: Copy fail (no AEC-PM2 or communication error)	0...1 7: display only	0

Copy parameters

It is now possible to copy settings to an accessory (AEC-PM2) and to copy them back to other MZ3. For this, remove the front panel of the MZ3, insert AEC-PM2 in the designated plug.

Copy parameters from MZ3 to AEC-PM2

Connect OPA-S and copy parameters from MZ3 to AEC-PM2 by setting OP06 to 1. The "Data" LED of the AEC-PM2 lights up for 5 seconds after successful parameter copying and OP06 is set to 0. If parameter copying has failed, the LED flashes for 5 seconds and OP06 is set to 7.

Copy parameters from AEC-PM2 to MZ3

Copy the parameters from AEC-PM2 to MZ3 simply by pressing the "Copy" button on the AEC-PM2. The "Data" LED on the AEC-PM2 will light for 5 seconds after the parameters have been successfully copied. If the parameter copy failed, the LED will blink for 5 seconds.

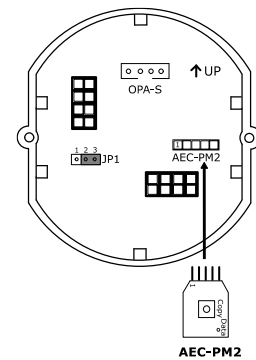

Calibration

The CO2 sensor unit is maintenance free in normal environments thanks to the built-in self-correcting ASC (Automatic-Self-Calibration) algorithm. This algorithm constantly remembers the sensor's lowest reading over a 7-day interval and slowly corrects any long-term deviation detected compared to the expected fresh air value of 400 ppm CO2.

However, rough handling and transportation may result in a decrease in sensor measurement accuracy. Over time, the ASC function will return the readings to the correct values. However, the preset correction rate is limited to approximately 30 ppm/week.

In the event that you cannot wait for the ASC algorithm to correct a calibration error, manual calibration can be activated using the following procedure.

Calibration to 400 ppm (with fresh air)

1. Connect the OPA-S to the MZ3 and expose the MZ3 to fresh outside air for at least 5 minutes. It is important that the CO2 sensor is exposed to fresh air only. An open window near the sensor with a higher CO2 concentration could prevent a stable signal. Observe the CO2 value on the OPA-S.
2. Once the CO2 value has stabilized, log on to the OPA-S and set the parameter IP02 = ON and exit configuration mode to start calibration.
3. As soon as the calibration has been performed, the parameter IP02 will change to OFF and the OPA-S will display a CO2 value in the order of 400 ppm.
4. If the calibration was not successful, wait at least 1 minute before repeating the procedure. Make sure that the sensor environment is calm!

Smart Sensors and Controls Made Easy!

Quality - Innovation – Partnership

Vector Controls GmbH
Switzerland

info@vectorcontrols.com
www.vectorcontrols.com

