

TLC3-BCR Series Thermostat



Features

- Low power energy consumption: < 1W per unit
- Relays switching for outputs each up to 300W
- Temperature control for 2 or 4-pipe heating or cooling systems.
- Optional external temperature input.
- **New Feature:** high temperature range of external input up to 150°C (302°F)
- Choose between one 3-point actuator and two binary heating/cooling stages
- Reversing valve options
- New with V3.1 dual stage option
- Cost saving option with Economy functionality and set point limitations
- Multiple auxiliary functions: heat-cool auto changeover, automatic enable, high or low limits.
- Password protected programmable user and control parameters.

TLC3-BCR-D also includes

- Power Cap protected real-time clock with 48hr power backup.
- Time schedule events, with many options.
- Blue backlight.

Applications

- Radiant heating
- Radiant cooling
- Small air handlers
- Constant air volume systems
- Frost protection
- General temperature control

General

- TLC3-BCR: 1 independent temperature control loop with 1 heating and 1 cooling sequence. 1 internal temperature sensor, 1 external temperature input, 1 auxiliary input for heat – cool changeover or high/low limit
- Flexible application configuration is made with a parameter-setting routine using the standard operation terminal.

Name

T L C 3 - B C R - U

Voltage: Blank = 230V, 0 = 24V, 1 = 120V
 Housing: Blank = square housing, U = 2x4" housing
 Outputs: R = Relays
 Control: BC = Binary Control, FC = Fan Coil control
 Series: **TLC3**

Ordering

Model	Item code	Variation	Option
TLC3-BCR-230	40-10 0158	Standard	Binary controller with: 1 RT int, 2 RT ext 2 DO (Relay) Binary valve control
TLC3-BCR-230-W01	40-10 0158-01	Cooling only	
TLC3-BCR-D-230	40-10 0159	Deluxe	
TLC3-BCR-D-230-W01	40-10 0159-01	Cooling only	

Temperature sensors: Use Vector Controls NTC sensors to achieve maximum accuracy: SDB-Tn10-20 (duct), SRA-Tn10 (room), SDB-Tn10-20 + AMI-S10 as immersion sensor.

Binary auxiliary devices (e.g. pumps, fans, on/off valves, etc): Do not directly connect devices that exceed specified limits in technical specifications – observe startup current on inductive loads.

Technical specifications

Notice! Failure to follow specifications and local regulations may cause equipment damage. Misapplication will void warranty.

Power Supply	Power Requirements	210 – 250 V AC 50/60 Hz
	Power Consumption	Max 1W, 1.5VA
	Electrical Connection	Terminal Connectors
	Clock backup	Min 48h if charged for 24h
Signal inputs	Temperature Inputs	RT Internal
	Range	0...50 °C (32...122 °F)
	Accuracy	0.5°C (1°F)
	Input type:	External (Sxx-Tn10 sensor)
Range	-40...150°C (-40...302°F)	
Accuracy	0.5°C (1°F) if 0...50°C (32...122°F) 1.0°C (2°F) if -40...100°C (-40...212°F) 5°C (10°F) if > 100°C (212°F)	
Signal outputs	Digital Switching Outputs	Y1 to Y2
	Switching Type	Relays
	AC Switching power	0...250V AC 1.25A max. each output
	Insulation strength	
between relays contacts and system electronics:	4000V AC	
between open relays contacts	1000V AC	
Environment	Operation	To IEC 721-3-3
	Climatic Conditions	class 3 K5
	Temperature	0...50 °C (32...122 °F)
	Humidity	<95 % r.H. non-condensing
	Transport & Storage	To IEC 721-3-2 and IEC 721-3-1
	Climatic Conditions	class 3 K3 and class 1 K3
Temperature	-25...70 °C (-13...158 °F)	
Humidity	<95 % r.H. non-condensing	
Mechanical Conditions	class 2M2	
Standards	conformity	
	RoHS Directive	2011/65/EU
	EMC Directive	2004/108/EC
	Low Voltage Directive	2006/95/EC
	Product standards	
	Automatic electrical controls for household and similar use	EN 60 730 –1:2011
	Special requirement on temperature dependent controls	EN 60 730 – 2 – 9:2010
	Electromagnetic compatibility for domestic sector	Emissions: EN 60 730-1:2011 Immunity: EN 60 730-1:2011
	Degree of Protection	IP30 to EN 60 529
	Pollution Class	II (EN 60 730-1:2011)
	Safety Class	II (IEC 61140:2001 + A1:2004)
	Overvoltage Category	III (EN 60 730-1:2011)
	Restriction of the use of certain hazardous substances	EN 50581:2012
	General	Dimensions (H x W x D)
Material:		Cover, back part: ABS plastic (UL94 class V-0) Mounting Plate: Galvanized Steel
Weight (including package)		Standard: 295g (10.4oz) Deluxe (-D): 305g (10.7oz)

Dimensions, mm (inch)

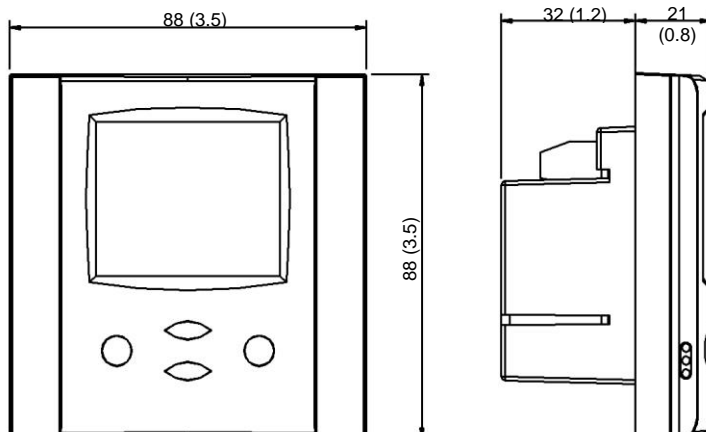

Space required in flush mounting box:
(H x W x D)
60 x 50 x 32mm (2.4 x 2.0 x 1.26 in.)

Distance for mounting screws:
Horizontal and vertical:
45 to 63mm (1.8 to 2.5 in.)

Connection

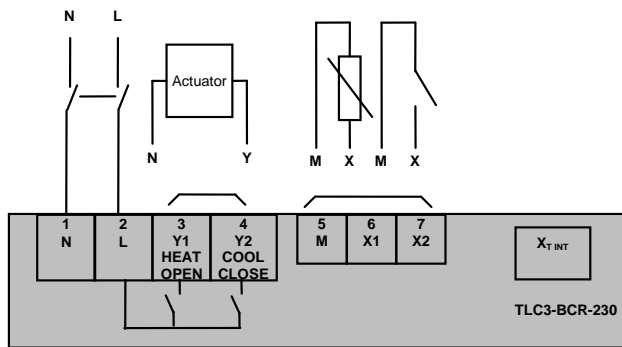

Warning:

Live Electrical Components!

During installation, testing, servicing and troubleshooting of Vector Controls products, it may be necessary to work with live electrical components. Have a qualified licensed electrician or other individual who has been properly trained in handling live electrical components perform these tasks. Failure to follow all electrical safety precautions when exposed to live electrical components could result in death or serious injury.

Terminal Description

N Power supply: 0V Neutral
L Power supply: 230VAC

Y1 Binary output 230V AC:
Heat for binary or PWM actuators if in 4-pipe or single stage mode
Open for 3-point actuators
Stage 1 if in reversing valve mode
Stage 1 if in 2-stage mode

Y2 Binary output 230V AC:
Cool for binary or PWM actuators if in 4-pipe mode or single stage mode
Close for 3-point actuators
Reversing valve if activated
Stage 2 if 2-stage mode

X1 External input: NTC 10kΩ @ 25°C (77°F) or open contact to SGND
Automatic detection for control input
or according to setup

X2 External input: NTC 10kΩ @ 25°C (77°F) or open contact to SGND
Changeover or remote control input

Mounting location

- Install the controller on an easy accessible interior wall, approx. 1.5 m above the floor in an area of average temperature.
- Avoid direct sunlight or other heat sources, e.g. the area above radiators and heat emitting equipment.
- Avoid locations behind doors, outside walls and below or above air discharge grills and diffusers.
- Location of mounting is less critical if external temperature sensors are used.
- Ensure adequate air circulation to dissipate heat generated during operation.
- Observe local regulations.
- Do not mount in wet or condensation prone environments.

Installation

1. Connect the wires to be connected to the terminals of the power case according to wiring diagram
2. Install the mounting plate to the flush mounting box. Make sure that the nipple with the front holding screw is facing to the ground. Make sure the mounting screw heads do not stand out more than 5 mm (0.2") off the surface of the mounting plate.
3. Ensure that the jumpers are set correctly.
4. Slide the two latches located on the top of the front part into the hooks at the upper side of the mounting plate.
5. Carefully lower the front part until the interconnector reaches the mounting-plate. Continue pressing in a gentle way until the front part is fully connected. While inserting the connectors, a slight resistance can be felt. This is normal. Do not use excessive force!
6. With a Philips-type screw driver of size #2, carefully tighten the front holding screw to secure the front part to the mounting plate. This screw is located on the front lower side of the unit. There is no need to tighten the screw too much.

Display and Operation

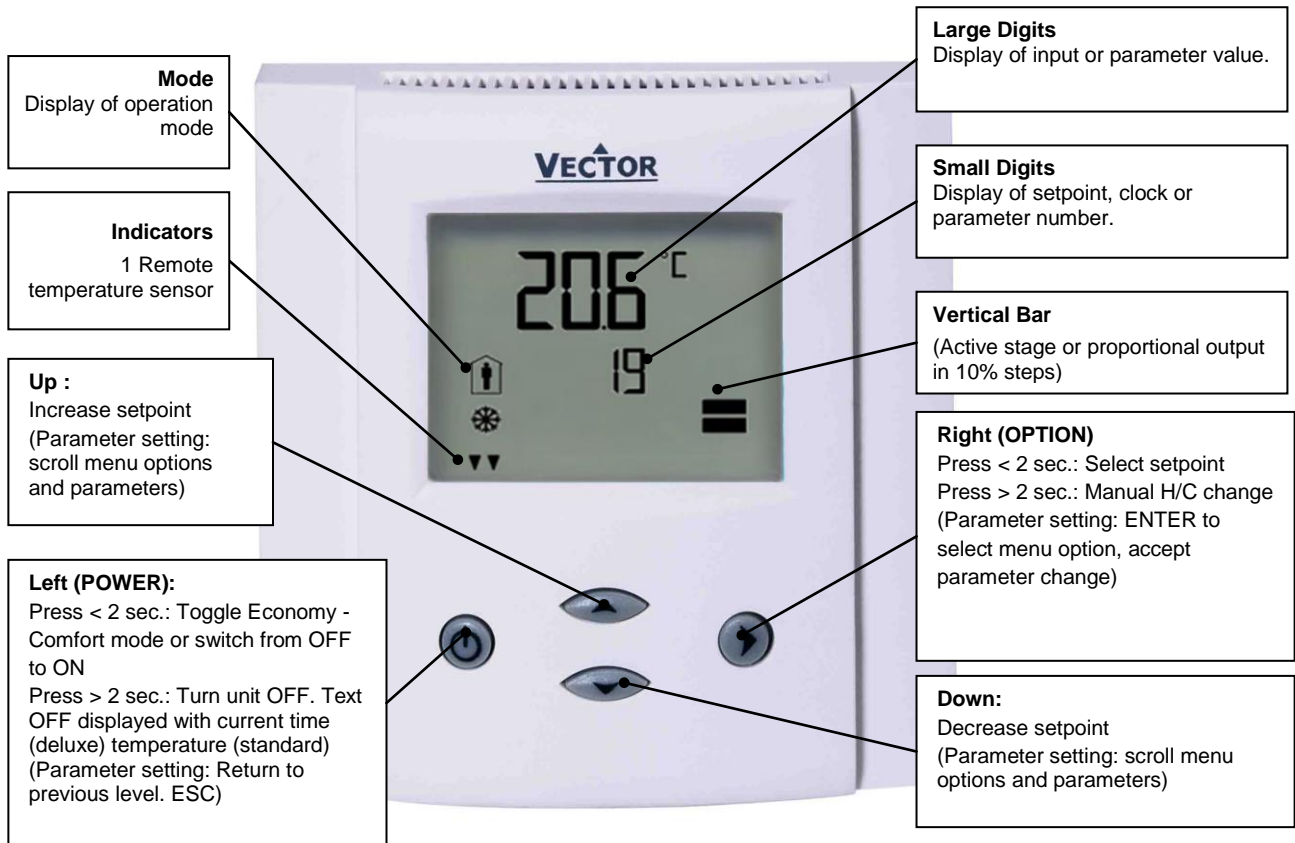

Operation mode

	Comfort (occupied)	All control functions operating per set points.
	Economy (unoccupied):	Set points shifted according to <i>Parameters CP04</i> . Economy mode and setpoint shift may be disabled with UP06
OFF	Energy Hold Off	Outputs are off, inputs monitored for alarm condition
	Heating	Output activates if temperature lower than setpoint
	Cooling	Output activates if temperature higher than setpoint
	Manual mode	Deluxe only: Override of time schedule active.
	Schedule	Deluxe only: Time schedule is active

Standard display (Parameters UP10, UP11)

- Active when no key has been pressed for 30 seconds.
- Contents may be chosen with parameters.

Loop display

- Active when changing set points. Large digits show input value. Small digits show set point. Vertical bars show analog output value. Arrows in position 1, 2 and/or 3 show active binary (digital) output stages

Power Failure

- All parameters and set points are memorized and do not need to be re-entered.
- Upon return of power: Set *Parameter UP05* to keep the unit off, switch on, or operation mode before power failure.
- Clock and time schedule settings retained for 48 hours (after powered for at least 10 hours).

Error messages



Err1: Error temperature sensor. The internal temperature sensor may be damaged or not present

FP: Steady: Frost protection is active.

Blinking: Frost protection activated in the past and is now inactive. Confirm with OPTION key.

Manual heat – cool change

To manually change heating or cooling mode press the OPTION key for more than 2 seconds. Access to manual heat – cool change may be disabled with parameter UP03.

For TLC3-BCR: For TLC3-BCR-D:	Press OPTION > 2 sec. SEL and H-C is displayed. Press OPTION > 2 sec. SEL and current time is displayed. Press UP key twice. SEL and H-C is displayed. Press OPTION again to toggle H or C.	SEL H-C  
----------------------------------	--	---

Clock operation

TLC3-BCR-D contains a quartz clock with battery back-up (not available in TLC3-BCR). Up to 8 mode changes based on time and day of the week may be programmed. Also position an output or select a set point directly with a time schedule. A blinking clock indicates that the time has not been set or that the unit has been without power for longer than 48 hours. The time needs to be set to allow time schedules to operate.

Clock setup

Press OPTION > 2 sec. SEL and current time displayed Press OPTION < 2 sec. to change time, Minutes blink: UP/DOWN to change, OPTION to save minutes, Hours blink: UP/DOWN to change, OPTION to save hour, Press OPTION to save time, DAY1 blinks: UP/DOWN to change, OPTION to save day	SEL 00:00 DAY1 (Mon)
--	----------------------------

Creating time schedules

There are a total of 4 switching events grouped into 4 time schedule group. A switching event consists of an operation mode and a switching time.

Step 1: Select time schedule group

Press OPTION > 2 sec. SEL and current time displayed Press UP: SEL and PRO displayed, clock symbol blinks Press OPTION: Select time schedule program. Pro 1 to Pro 4. PRO 1 is shown. 1 is blinking. UP/DOWN to change, OPTION to select	SEL PRO 	Pro 1 to Pro 4 OFF/ON
---	---	--------------------------

Step 2: Enable/disable time schedule group

Pro x is fixed now, ON / OFF blinks Press UP/DOWN to set ON or OFF. This disables or enables the time schedule group. Press OPTION to continue In case OFF has been selected, return to Step 1. If ON is selected, continue to step 3.	Pro 1 OFF/ON
--	-----------------

Step 3: Selected switching day (Pr01) to DAY1 (Mon) – DAY 7 (Sun) for time schedule group

While Pro1 is displayed and day selection is blinking: Press UP / DOWN: select day group: d1-7, d1-5, 1-6, d6-7, day 1, day 2, day 3, day 4, day 5, day 6, day 7 d1-7 will activate the time schedule group for all 7 week days, d1-5 activates it only for day 1 (Mon) to day 5 (Fri) etc. Press OPTION to save day selection and move to first switching event.	Pr01 DAY1
---	--------------

Step 4: Select action for switching event

The bar on the right side indicates the current number of the switching event. There are a total of 4 switching events per group. Press UP / DOWN to select desired operation mode. (no, OFF, ECO, ON, UNI), no = disables this switching time OFF = switches unit Off, enables reset timer ECO = sets operation mode to On and Economy, disables reset timer ON = sets operation mode to On and Comfort, disables reset timer UNI = Does not change operation mode, only disables reset timer Press OPTION to continue	Pr01 no 
--	---

Step 5: Select a switching time for switching event

Press UP / DOWN Switching time 07:30 blinks. Select switching time in 15 min steps from 00:00–23:45. Press OPTION to save switching time:	Pr01 08:00 
---	--

Step 6: Complete time schedule group definition

Repeat steps 4 and 5 for all 4 switching events. In case a switching event is not used, set its mode to "no". To review the entire schedule group, step through by repeatedly pressing the OPTION key from step 1 onwards to step 6.	Pr01 08:00 
---	--

Setting parameters to configure the controller

TLC3-BCR is an intelligent programmable thermostat with the flexibility to fit a wide range of applications. The control operation is defined by parameters set using the standard operation terminal. There are two levels:

1. **User/display parameters (password 0009)**
2. **Control parameters (password 0241)**

Recommended set-up procedure:

1. **Connect power supply and inputs**
2. **Make sure Celsius – Fahrenheit settings are correct (UP07)**
3. **Program control parameters**
4. **Program user settings**
5. **Test function of unit**
6. **Switch off power**
7. **Connect outputs**
8. **Test control loop**

Parameters are grouped according to modules:

Module	Description	Notes	PW
UP	User Configuration	Control user access and display elements, regional settings	009
CP	Controls Configuration	Configuration of control loop, setpoint limits, type and function of inputs and type of outputs	241

How to change parameters

1. Press UP/DOWN buttons simultaneously for three seconds. The display will show firmware version and revision number. Press the OPTION button to start login.
2. CODE is shown in small display.
3. Code to access user parameters is 009, control parameter is 241. The access numbers are fixed and cannot be changed.
4. Select this using UP/DOWN buttons.
5. Press OPTION after selecting the correct code.
6. Once logged in, the parameters are displayed immediately.
7. Select the parameters with the UP/DOWN buttons. Change a parameter by pressing the OPTION button. Three arrows are displayed to indicate that the parameter may be modified. Use UP/DOWN buttons to adjust the value.
8. After you are done, press OPTION to save the new value and return to the selection level (arrows disappear when selection is saved). Pressing left hand POWER button without pressing OPTION will discard the value and return without saving. For control parameters press POWER again to leave parameter selection and return to control module selection.
9. Press the POWER to leave the menu. The unit will return to normal operation if no button is pressed for more than 5 minutes

User and display parameters (password 009)

Parameter	Description	Range	Default
UP 00	Enable change of operation modes,	ON, OFF	ON (Enabled)
UP 01	Enable change of set points	ON, OFF	ON (Enabled)
UP 02	Parameter not used	ON, OFF	ON
UP 03	Enable manual Heat/Cool change	ON, OFF	W00 = ON W01 = OFF
UP 04	Enable Access to time programs	ON, OFF	ON (Enabled)
UP 05	State after power failure: 0 = OFF, 1 = ON, 2 = Last State	0, 1, 2	2
UP 06	Enable Economy (unoccupied) Mode. Shift the setpoint to a lower temperature in winter or higher temperature in summer in order to save energy. May be activated through the POWER button, or with the external input (typically for key card switches in hotel rooms or motion detectors for meeting rooms.)	ON, OFF	ON (Economy)
UP 07	Celsius or Fahrenheit, OFF for Celsius, ON for Fahrenheit	ON, OFF	OFF (Celsius)
UP 08	Calibrate internal temperature sensor -10° to +10° in 0.1° steps. (Sensor is factory calibrated, use this feature for field adjustment only as required.)	-10...10	0
UP 09	Enable Frost Protection. Switches to heating mode and activates the output when the control temperature drops below 5°C or 41°F. The controller returns to normal operation when the temperature increases above 10°C or 50°F.	ON, OFF	W00 = ON W01 = OFF
UP 10	Select contents of Large LCD display in standard mode:	0...6	02 Temperature
	00 = OFF 01 = Setpoint 02 = Temperature Sensor 03 = Output Mode		
UP 11	Select contents of small LCD display in standard mode	0...6	Standard: 01 Setpoint Deluxe: 04 Clock
	00 = OFF 01 = Setpoint 02 = Temperature Sensor 03 = Output Mode		
UP 12	Clock display type: Only available for deluxe version OFF = Show 24hour clock ON = Show 12hour clock (AM, PM)	ON, OFF	OFF (24h)
UP 13	Reset timer for override mode: Only available for deluxe version 0 = Reset of override mode is not active. 1...255 = delay in minutes to switch off device if ON/Economy mode is activated while the unit is scheduled to be in OFF mode	0...255	60 (Min)

Control configuration (Password 241)

Warning! Only experts should change these settings!

Setpoint Limits

Parameter	Description	Range	Default
CP 00	Minimum set point limit in heating mode	-40-60°C *1	16°C (61°F)
CP 01	Maximum set point limit in heating mode	-40-60°C *1	24°C (76°F)
CP 02	Minimum set point limit in cooling mode	-40-60°C *1	18°C (65°F)
CP 03	Maximum set point limit in cooling mode	-40-60°C *1	30°C (87°F)

*1) if CP21 = OFF: -40...60°C (-40...140°F), if CP21 = ON: -40...160°C (-40...320°F)

Controls Configuration

CP 04	Economy (unoccupied) Mode temperature shift: The comfort (occupied) setpoint is shifted by the value set with parameter. If heating is active the comfort setpoint will be decreased, if cooling is active, the setpoint will be increased. (Enable with UP06.)	0-10.0°C	5°C (10°F)
CP 05	Dead Zone Span: The Dead Zone Span lies between the heating and the cooling setpoint. The output is off while the temperature is within the dead zone span. A negative dead zone is not possible.	0-100°C	1.0°C (2°F)
CP 06	Heat/Cool Changeover Delay (if set to CP12 = 4): A demand to switch between heating and cooling must persist for the length of time set with this parameter before the controller switches. Prevents activation of a sequence during a short-term change in temperature in order to protect equipment (with control overshoot for example)	0...255 min	5 min
CP 07	P – band or switching span heating X_{PH}	0-10.0°C	2.0°C (4.0°F)
CP 08	P – band or switching span cooling X_{PC}	0-10.0°C	2.0°C (4.0°F)
CP 09	Switching Hysteresis is the difference between switching on and switching off. A small hysteresis will increase the number of switching cycles and thus the wear on associated equipment.	0-10.0°C	0.5°C (1°F)
CP 10	Delay OFF (Minimum running time), The minimum time the output is running once it switches on.	0...255 s	10s
CP 11	Delay ON (Minimum stopping time) The minimum time the output is off, once it switches off.	0...255 s	10s
CP 12	Control option: 0 = Cooling only 1 = Heating only 2 = 2-pipe system: No demand based heat – cool switching 3 = 4-pipe system: Demand based heat – cool switching	0...3	Default = 3 W01 = 0 W02 = 1 W03 = 2 W04 = 3

→ Proportional control (P-band)

The proportional control function calculates the output based on the difference between setpoint and measured value. The proportional band (P-band) defines the difference between setpoint and measured value which will result in a 100% output. For example, with a heating or reverse 0-10v control sequence, and a 2.0°C (4.0°F) P-band value, at 10v the controller will be 2.0°C (4.0°F) below setpoint. This is the working range of the proportional control sequence.

Setting the proportional band to 0 disables proportional control.

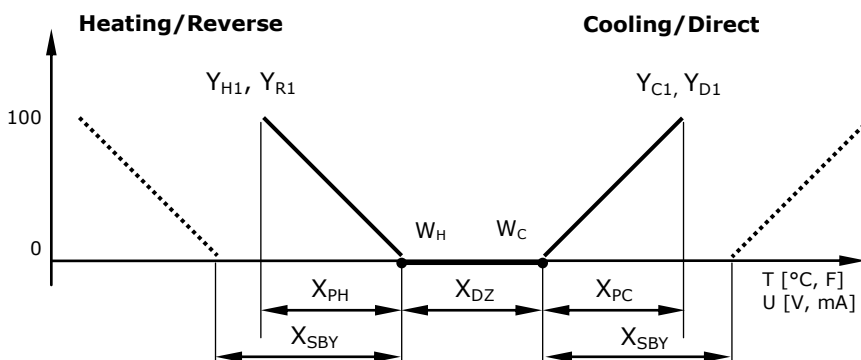

Legend

T, U	Input signal temp/universal
X_{PH}	P-band heating/direct
X_{PC}	P-band cooling/reverse
X_{DZ}	Dead zone h/c set points
X_{SBY}	Economy mode set point shift
W_H	Set point heating/reverse
W_C	Set point cooling/direct
Y_{H1}, Y_{R1}	PI sequence heating/reverse
Y_{C1}, Y_{D1}	PI sequence cooling/direct

Output configuration

Parameter	Description	Range	Default
CP 13	Output setting, Binary, PWM or 3-point: 0 = Binary or PWM (See CP14 for assignment of Y1 and Y2) 1 = 3-point binary output (Y1 open, Y2 close) 2 = 3-point floating output (Y1 open, Y2 close)	0..2	0 Binary / PWM
CP 14	Reversing valve in binary mode 0 = no reversing valve, one stage only (Y1 Heating, Y2 Cooling) 1 = rev. valve while heating (Y1 stage 1, Y2 rev valve) 2 = rev. valve while cooling (Y1 stage 1, Y2 rev valve) 3 = no reversing valve, two stages (Y1 stage 1, Y2 stage 2)	0...3	0
CP 15	Running Time in 3-point mode	0...255 s	90 s
CP 16	PWM cycle time, 0 disables PWM mode	0...100 min	0

→ On-Off control

Two devices may be controlled in case the output setting is 0 (CP13). Y1 controls a heating and Y2 a cooling device if in single stage mode. If in 2-stage mode (CP14 = 3) Y1 controls stage 1 and Y2 stage 2. The switching span for stage 2 is defined by the P-band (X_{PH} , X_{PC}).

→ PWM output:

Fine-tuned proportional control with one binary output is possible thanks to Pulse Width Modulation (PWM).

Conventional fan coil controllers will operate in an on-off control mode. The valve is opened until the setpoint is reached and then closed. As heating or cooling systems are normally slow acting (heating slower than cooling), this will lead to a relatively wide fluctuation of the room temperature as the temperature will overshoot the setpoint and undershoot the hysteresis.

With PWM the ON-OFF ratio of the output is determined by the proportional controller. The interval is the PWM cycle time. We recommend 8 min for cooling systems and 15min for heating systems. Cycle times depend on the room and the heating or cooling device.

Set the cycle time to 0 to disable PWM and activate conventional on-off control mode (Factory default).

→ 3-point output

A 3 point actuator has an open and a close input. Applying power to the open input will drive the valve or damper open, applying power to the close input will drive the valve or damper to the closed position.

The running time of the actuator may be preset. We recommend to enter the maximum running time under maximum load in order to make sure that the valve can fully close and fully open in any circumstance.

In order to open the valve or damper Y1 will be activated for the preset amount of time. After the expiration of the running time Y1 and Y2 will be OFF. The valve is closed by activating Y2 for the preset amount of time.

→ 3-point on-off mode

In on-off mode the actuator is either fully opened or fully closed. This is used for some (mostly fast running) zone valves that are not equipped for frequent start – stop cycles. Binary control is active in this mode.

→ 3-point floating mode

The actuator position is modulated by the controller using proportional control. The position is calculated based on summarized opening and closing times. The software contains a synchronization algorithm to guarantee accurate positioning even after extended running time. Proportional control is active.

→ Reversing valve

In binary output mode a reversing valve option is available. A reversing valve is used where a compressor is used to generate heating and cooling. Select 1 if the reversing valve is to be activated while in heating mode, select 2 if the reversing valve is active while the unit is in cooling mode.

The reversing valve will open based on its settings once the operation mode is ON and the either the heating or the cooling sequence is active.

→ Control Logic if CP13 = 0

The proportional control function calculates the output based on the difference between setpoint and measured value. The proportional band (P-band) defines the difference between setpoint and measured value which will result in a 100% output. For example, with a heating or reverse 0-10v control sequence, and a 2.0°C (4.0°F) P-band value, at 10v the controller will be 2.0°C (4.0°F) below setpoint. This is the working range of the proportional control sequence.

System type	CP14	Y1	Y2
2 pipe system heat or cool	0	Heat	Cool
4 pipe system Heating mode	0	Heat	
4-pipe system Cooling mode	0		Cool
4-pipe reversing valve on Heat	1	Stage 1	Rev valve (in heat mode)
4-pipe reversing valve on Cool	2	Stage 1	Rev valve (in cool mode)
2-pipe system heat of cool, 2 stages	3	Stage 1	Stage 2

Input configuration X2

Parameter	Description	Range	Default
CP 17	Changeover input: 0 = No external input 1 = Occupation sensor – Comfort / Economy 2 = Occupation sensor – Comfort / Off 3 = Heat / Cool change over, heat cool change if over limit 4 = High / Low limit supervision, outputs switch off if over limit	0...6	0
CP 18	Activation delay (Minutes) = the time the binary input needs to be open before Economy/off mode is activated if CP17 = 1, 2. Does not apply for heat cool changeover or high/low limit	0...255 min	5
CP 19	Heat – cool changeover limit heating if CP17 = 3 Low limit if CP17 = 4	-40-60°C*1	16°C (61°F)
CP 20	Heat – cool changeover limit cooling if CP17 = 3 High limit if CP17 = 4	-40-60°C*1	28°C (83°F)
CP21	New Feature with V3.2 Set input range of external inputs: OFF = input range -40°C to 60°C ON = input range -40°C to 160°C Note: Temperature limit parameters and the control loop set point need to be manually adjusted after this change.	ON, OFF	OFF

*1) if CP21 = OFF: -40...60°C (-40...140°F), if CP21 = ON: -40...160°C (-40...320°F)

→ **Configuring the function of the external change over input**

CP17 = 0	CO input not used	
CP17 = 1	Switching Economy and Comfort modes	Economy (unoccupied) and Comfort (occupied) modes are controlled through an external contact by connecting X2 through a dry contact to signal common. This function may be used together with key card switches for hotels or motion detectors for offices.
CP17 = 2	Switching Energy Hold OFF and Comfort modes	Opening the X2 temperature input will force the unit into the OFF operation mode. The operation mode cannot be overridden by using the terminal. Connecting X2 input to GND returns control of the operation mode to the terminal. This function may be used as window contact to prevent loss of energy.
CP17 = 3	Heat – Cool changeover	Switch heating and cooling mode based on supply media or outside temperature or binary contact. See below for further details.
CP17 = 4	High – Low limit supervision	This may be used for a high temperature limit for floor heating or dew point sensor input for cooling ceilings. Output will switch off if contact opens.

→ **Configuring auto changeover input if CP17 = 3:**

The auto changeover function automatically changes heating and cooling mode based on supply media temperature or outdoor temperature. The difference between the two is in the values of the changeover limits CP19 and CP20. See table below for recommended settings.

Heating and cooling may be as well changed by an open contact switched to signal ground. Note: all signal ground levels of involved controllers must be the same in case more than one controller is switched.

→ **Recommended settings for CP19 and CP20:**

Change over mode CP17=3	Relation CP19 to CP20	Example CP19	Example: CP20
Supply media	CP19 > CP20	25°C (77F)	18°C (64F)
Outside temperature	CP19 < CP20	15°C (59F)	25°C (77F)
Dry contact: Heating if contact closed	CP19 > CP20	25°C (77F)	15°C (59F)
Dry contact: Cooling if contact closed	CP19 < CP20	15°C (59F)	25°C (77F)
Change over mode CP17=4	Relation CP19 to CP20	Example CP19	Example: CP20
Output off if outside range	CP19 < CP20	15°C (59F)	45°C (113F)
Dry contact: OFF if contact closed	CP19 < CP20	-40°C (-40F)	45°C (59F)
Dry contact: OFF if contact open	CP19 < CP20	15°C (59F)	80°C (176F)