

TCI-W11-U, TCI-W22-U Series Wall Mounted Universal Controller

Features

- Universal PID and/or binary control for any analog input/output signal and range.
- Multiple auxiliary functions: heat-cool auto changeover, automatic enable, setpoint compensation.
- Differential, averaging, min and max functions
- Cascading of control loops (-W22 type).
- Alarm monitoring of low and high limits on all inputs.
- Programmable reaction in case of alarm.
- Feedback function for inputs and set points.
- Functions for dehumidifying, set point shift, cascade control.
- Password protected programmable user and control parameters.



TCI-W11-U



TCI-W22-U

TCI-W22-U also includes

- Blue backlight
- Power Cap protected real-time clock with 48hr power backup.
- Clock with up to 8 switching events
- 7-day programmable schedules, with options including change of setpoints and direct position of manual outputs.

Applications

- Fan coil units
- Heat exchangers
- Zoning
- VAV
- Air handlers
- Fan, Pump control
- Humidifiers
- Dehumidifiers
- Ventilation
- Radiant heating
- Radiant cooling
- Pressurization

General

- **TCI-W11-U:** 1 independent control loop, 1 internal temperature sensor, 1 universal input (analog/binary/temp), 2 binary/PWM outputs, 1 analog output
- **TCI-W22-U:** 2 independent control loops, 8 time schedules, 1 internal temperature sensor, 2 universal inputs, 2 binary/PWM outputs, 1 analog output
- Internal temperature sensor standard. Add replaceable humidity element as required: AES3-HT-A2 (2%), AES3-HT-A3 (3%), or AES3-HT-A5 (5%)
- Flexible application configuration is made with a parameter-setting routine using the standard operation terminal.

Product Name

T C I - W 2 2 - U

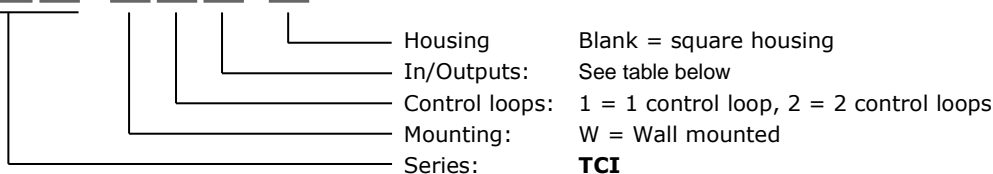

Types and Ordering

Product Name	Product No.	Loop	Temperature Sensor (internal)	Humidity Sensor (internal)	Universal Input	Binary Output	Analog Output	Time Schedules	Option
TCI-W11-U	40-10 0265	1	1	0	1	2	1	0	Standard
TCI-W11-U-H	40-10 0266			1					rH Sensor 3% acc.
TCI-W22-U	40-10 0269	2	1	0	2	1	8	Time schedules	
TCI-W22-U-H	40-10 0270			1				rH Sensor 3% acc.	
AES3-HT-A2	40-50 0102			1					rH Sensor 2% acc.
AES3-HT-A3	40-50 0103			1					rH Sensor 3% acc.
AES3-HT-A5	40-50 0104			1					rH Sensor 5% acc.

Temperature sensors: Use Vector Controls NTC sensors to achieve maximum accuracy: SDB-Tn10-20 (duct), SRA-Tn10 (room), SDB-Tn10-20 + AMI-S10 as immersion sensor.

Actuators: Choose modulating actuators with an input signal type of 0-10 V DC or 4-20 mA (Min. and max. signal limitations may be set with parameters. 3-pointpoint actuators with constant running time are recommended.

Binary auxiliary devices (e.g. pumps, fans, on/off valves, humidifiers, etc): Do not directly connect devices that exceed specified limits in technical specifications – observe startup current on inductive loads.

Technical specifications



WARNING!

This device is intended to be used for comfort applications. Where a device failure endangers human life and/or property, it is the responsibility of the owner, designer and installer to add additional safety devices to prevent or detect a system failure caused by such a device failure. The manufacturer of this device cannot be held liable for any damage caused by such a failure.

Ignoring specifications and local regulations may endanger life, cause equipment damage and void warranty.

Power Supply	Power Requirements	24 VAC $\pm 10\%$, 50/60 Hz, Class 2, 2.0 A, 48 VA max. 24 VDC $\pm 10\%$
	Power Consumption	Max. 3 VA
	Electrical Connection	Terminal Connectors 0.34...2.5 mm ² wire (AWG 24...12)
	Clock backup	Min. 48 hours
Signal inputs	Universal Input	Setting for Voltage or Current
	Input Signal	0–10 V or 0–20 mA
	Resolution	9.76 mV or 0.019 mA (10 bit)
	Impedance	Voltage: 98k Ω Current: 240 Ω
	Universal Input	Input configured to remote temperature (RT) or digital input (DI)
	Range	NTC (Sxx-Tn10 sensor): -40...140 °C (-40...284 °F)
	Accuracy	-40...0 °C (-40...32 °F): 0.5 K 0...50 °C (32...122 °F): 0.2 K 50...100 °C (122...212 °F): 0.5 K > 100 °C (> 212 °F): 1 K
	Humidity Sensor AES3-HT-Ax:	Capacity sensor
	Range	0...100 % rH
	Measuring Accuracy	See Figure to the right
Hysteresis	$\pm 1\%$	
Repeatability	$\pm 0.1\%$	
Stability	< 0.5% / year	
<p>Figure 1: Max RH-tolerance at 25°C (77°F) per sensor type</p>		
Signal outputs	Analog Output	DC 0–10 V / 0–20 mA
	Output Signal	9.76 mV / 0.019 mA
	Resolution	Voltage: $\geq 1k\Omega$ Current: $\leq 250\Omega$
	Maximum Load	
Relays Outputs	AC Voltage	0...48 VAC, 2(1.2)A max. (Observe local regulation)
	DC Voltage	0...30 VDC, 2A max.
	Insulation strength between relays contacts and system electronics:	2000V AC to EN 60 730-1 1250V AC to EN 60 730-1
Environment	Operation	To IEC 721-3-3
	Climatic Conditions	class 3 K5
	Temperature	0...50 °C (32...122 °F)
	Humidity	<95 % RH non-condensing
	Transport & Storage	To IEC 721-3-2 and IEC 721-3-1
	Climatic Conditions	class 3 K3 and class 1 K3
Temperature	-25...70 °C (-13...158 °F)	
Humidity	<95 % RH non-condensing	
Mechanical Conditions	class 2M2	
Standards	Degree of Protection	IP30 to EN 60 529
	Pollution Class	II (EN 60 730-1)
	Safety Class	III (IEC 60536)
	Overvoltage Category	I (EN 60 730-1)
General	Material:	Cover, back part: Fire proof ABS plastic (UL94 class V-0) Mounting Plate: Aluminum
	Dimension (H x W x D)	Front part: 21 x 88 x 88mm (0.8 x 3.5 x 3.5 in.) Power case: \varnothing 58 x 32 mm (\varnothing 2.3" x 1.3")
	Weight (including package)	
	TCI-W11-U	205g (7.2 oz.)
	TCI-W22-U	220g (7.8 oz)

Product testing and certification



Declaration of conformity

Information about the conformity of our products can be found on our website www.vectorcontrols.com on the corresponding product page under "Downloads"

Wiring and Connection



WARNING! Live Electrical Components

During installation, testing, servicing and troubleshooting of Vector Controls products, it may be necessary to work with live electrical components. Have a qualified licensed electrician or other individual who has been properly trained in handling live electrical components perform these tasks. Failure to follow all electrical safety precautions when exposed to live electrical components could result in death or serious injury

TCI-W11-U

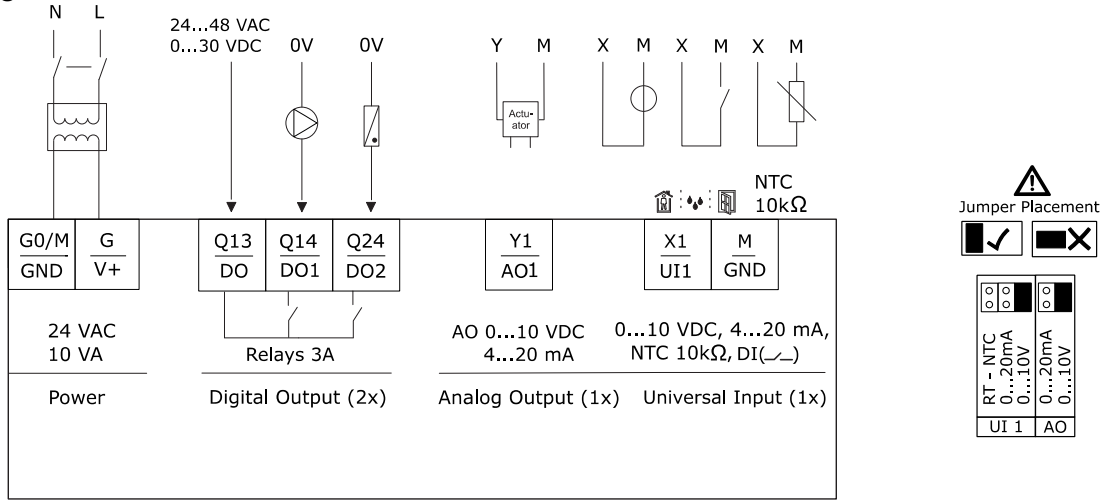

TCI-W22-U

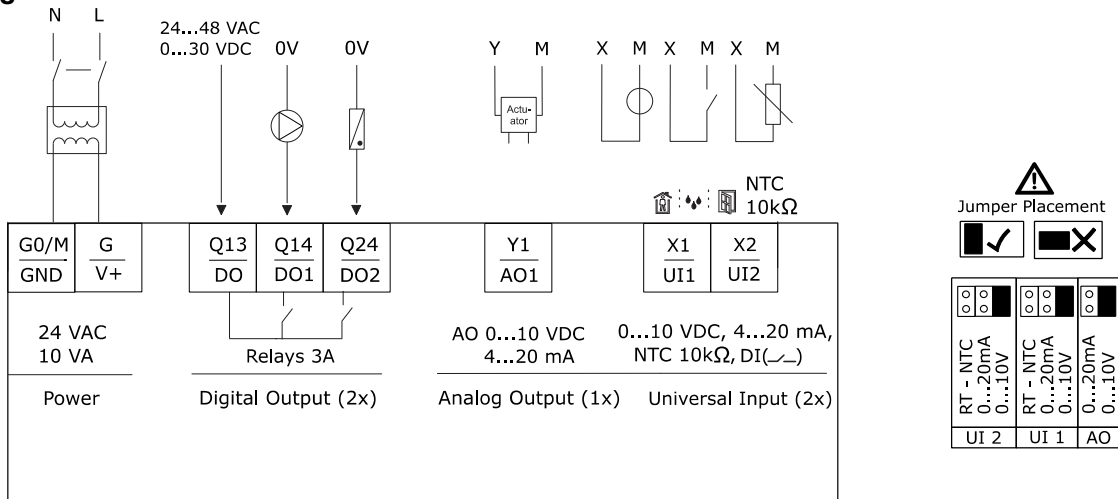

- GND** Power supply: 0V, -24VDC; common for power supply, analog in- and outputs
- V+** Power supply: 24VAC, +24VDC
- DO..** Binary outputs: Potential free relays contacts (see technical specification)
- UI..** Universal input: NTC 10kΩ @ 25°C (77°F), 0...10 V or 0...20 mA (selectable by jumper)
- AO..** Analog output: 0...10 V or 0...20 mA (selectable by jumper)

Use copper, twisted pair, conductors only. The operating voltage must comply with the requirements for safety extra-low voltage (SELV) as per EN 60 730. Use safety insulating transformers class II with double insulation as per EN 60 742; they must be designed for 100% ON-time. When using several transformers in one system, the connection terminal 1 must be galvanic connected. TCI is designed for operation of AC 24 V safety extra-low voltage and is short-circuit-proof. Supplying voltages above AC 24 V to low voltage connections may damage the controller or other devices. Connection to voltages exceeding 42 V endangers personnel safety.

Jumper Settings



See TCI-W installation sheet no. 70-000539 for details (www.vectorcontrols.com).

Mounting Location

- Install the controller on an easy accessible interior wall, approx. 1.5 m above the floor in an area of average temperature.
- Avoid direct sunlight or other heat sources, e.g. the area above radiators and heat emitting equipment.
- Avoid locations behind doors, outside walls and below or above air discharge grills and diffusers.
- Location of mounting is less critical if external temperature sensors are used.
- Ensure adequate air circulation to dissipate heat generated during operation.
- Observe local regulations.
- Do not mount in a wet or condensation prone environments.

Installation instructions

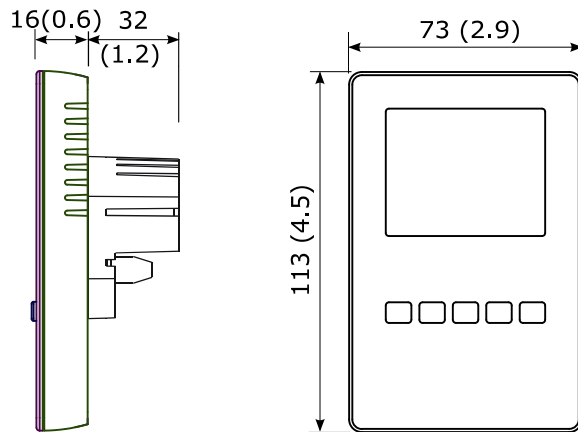

See TCI-W installation sheet no. 70-000539 (www.vectorcontrols.com).

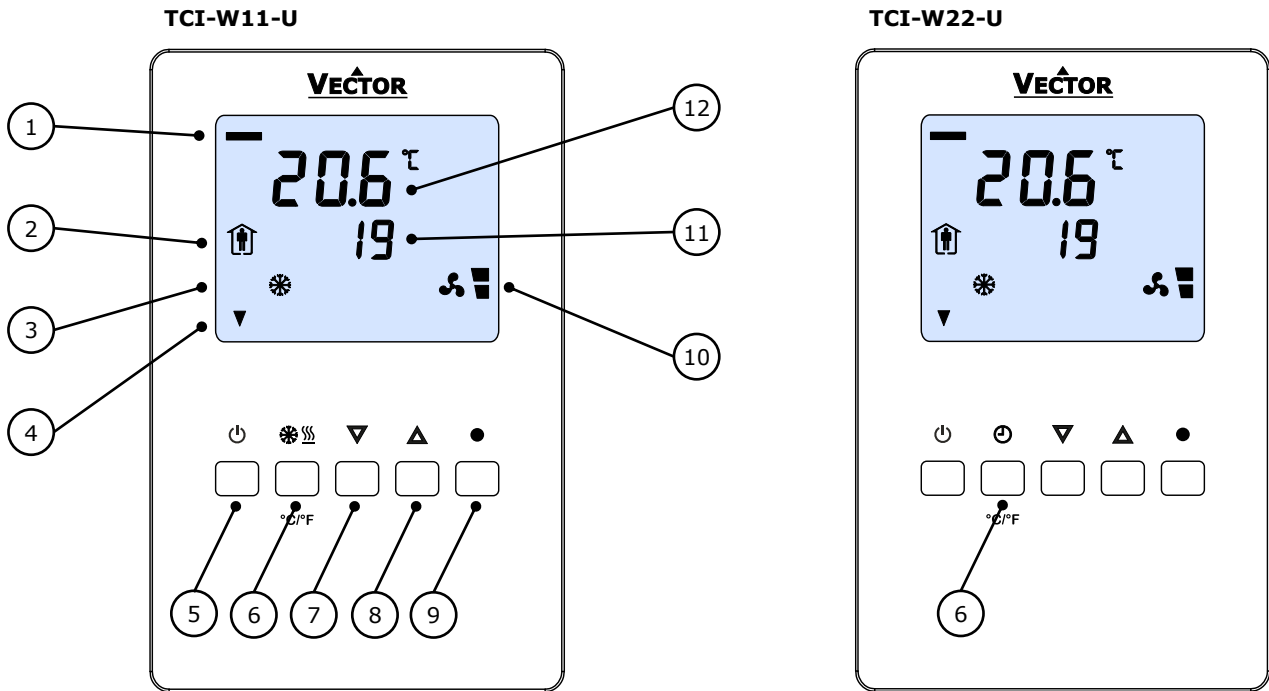
Dimensions mm (inch)





Display and Operation

Pos.	Function / Description
1	Loop indication - Standard display (no button pressed for 30 sec.): Not visible - Loop display: Bar at far left = Loop 1, Bar toward right = Loop 2
2	Operating Mode - Display of operation mode
3	Controlling Mode - Display of control mode
4	Indicators - Standard display: Active digital output (arrow at far left=1, toward right=2)
5	Operating Mode (POWER)(Back) - Press < 2 sec.: Toggle OCCUPIED/UNOCCUPIED mode or switch from OFF to ON - Press > 2 sec.: Turn unit OFF. Text OFF displayed with current time (W22) temperature (W11) - (Parameter setting: BACK to previous menu) - (Menu navigation: Back to previous/home menu)
6	OPTION , , , °C/°F - Press > 2 sec.: Enter set-up CLOCK (TCI-W22), SCHEDULES (TCI-W22), H/C, °C/°F
7	DOWN (-) - Decrease SET POINT - (Parameter setting: SCROLL menu options and parameters)
8	UP (+) - Increase SET POINT - (Parameter setting: SCROLL menu options and parameters)
9	RIGHT (Calibration) (Enter) - Press < 2 sec.: Select Control Loop - Press > 2 sec.: Enter sensor calibration - (Parameter setting: ENTER to select menu option, accept parameter change)
10	Vertical Bar - Display of input/output value with 10% resolution - (Parameter setting: Displays programming step)
11	Small Digits - Display of setpoint, clock or parameter number
12	Large Digits - Display of measured room temperature, input or parameter value

Operating Mode

Display	Description
	Occupied (Comfort) - All control functions operating per set points
	Unoccupied (Economy) - Set points shifted according to 1L07, 2L07
OFF	Protection (Energy Hold Off) - Outputs are off, inputs monitored for alarms

Controlling Mode

Display	Description
	Cooling - Cooling (Direct) Active
	Heating - Heating (Reverse) Active
	Manual - Manual Override
	Clock / Schedules - Schedule Set
	Fan - Fan Active

Operation Status

Display	Description
	Alarm - Alarm active

Standard display (Parameters UP08, UP09, UP10)

- Active when no key has been pressed for 30 seconds.
- Contents may be chosen with parameters.

Loop display

- Active when changing set points.
- Large digits show input value if 1L 27 or 2L 27 = OFF. Small digits show set point. If 1L 27 or 2L 27 = ON, only the setpoint is shown in the large digits.
- Vertical bars show analog output value. Arrows in position 1, 2 and/or 3 show active binary (digital) output stages

Display in OFF mode

- When the device is switched off, all enabled input values and the clock are displayed each for 4 seconds on the large LCD digits in a continuous cycle while OFF is displayed in the small digits. To prevent this, make sure that in idle mode no input values are shown on either small or large digits by setting UP09 and UP11 to something else than 1.

Override of secondary set point in cascade control

- If cascade control is active, with variable air volume (VAV) for example, the user can override the primary loop and manually select the set point of the secondary loop-the loop is now changed to constant air volume (CAV). Typically for tuning the VAV system. This feature may be disabled with UP02.
- While the secondary loop is displayed change the set point with UP/DOWN $\Delta \nabla$. Override Cascade symbol appears.
- Press OPTION to move back to the temperature loop and cancel cascade override.

Power Failure

- All parameters and set points are automatically saved and do not need to be re-entered.
- Upon return of power: Set *Parameter UP05* to keep the unit off, switch on, or operation mode before power failure.
- Clock and time schedule settings retained for 48 hours (after powered for at least 10 hours).

Alarm messages

Small Digit	LCD Symbol	Alarm Condition
ALA1 – ALA8		Alarm for low/high input or output limits according to configuration.







For details on configuring alarms see input configuration on page 11, output configuration on page 15, or auxiliary function on page 19.

Error messages

Large Digit	Error Condition
Err1	An assigned input is not enabled or missing. All control loops, functions and outputs tied to this input will be disabled. Verify input connections, jumper settings and parameter settings for the input involved.
Err3	A function refers to a disabled input. Disable the function or enable the input.
Err4	Internal failure. Product must be replaced.

Manual heat – cool change

To manually change heating or cooling mode press the OPTION key   (TCI-W11-U) or  (TCI-W22-U) for more than 2 seconds. Access to manual heat – cool change may be disabled with parameter UP03.

For TCI-W11: Press OPTION > 2 sec. SEL and H-C is displayed. For TCI-W22: Press OPTION > 2 sec. SEL and current time is displayed. Press UP until SEL and H-C is displayed. Press RIGHT ● to toggle H or C.	SEL H-C  
----------------------------------------------------------------------------------------------------------------------------------------------------------------------------------------------------------------------	---------------------------------------------------------------------------------------------------------------------------------------------------------------------------------------

Display input values



For TCI-W11: Press OPTION > 2 sec. SEL and H-C is displayed. Press UP until UI1 and its value are displayed. For TCI-W22: Press OPTION > 2 sec. SEL and current time is shown. Press UP until UI1 and its value are displayed. Press UP key again to step through the next active input Note: disabled inputs will not be shown.	75% UI 1
-------------------------------------------------------------------------------------------------------------------------------------------------------------------------------------------------------------------------------------------------------------------------------------------------------------------------------------------------	-------------

Sensor Calibration

Sensor inputs can be calibrated if needed.

Press RIGHT ● > 2 sec. UI and its value is displayed, Press RIGHT ●: Calibration value and tool symbol is displayed, UP/DOWN to calibrate, Press RIGHT ●: Save calibration, tool symbol disappears. Press UP key again to step through the next active input Note: disabled inputs will not be shown.	75% UI 1 0.0% ..UI 1 
----------------------------------------------------------------------------------------------------------------------------------------------------------------------------------------------------------------------------------------------------------------------------------------------------------------------	------------------------------------------------------------------------------------------------------------------------

Identification of software version used

Press UP/DOWN   buttons simultaneously for three seconds. The display will show firmware version and revision number.

Clock operation

TCI-W22-U contains a quartz clock with battery back-up (not available in TCI-W11-U). Up to 8 mode changes based on time and day of the week may be programmed. Also position an output or select a set point directly with a time schedule. A blinking clock indicates that the time has not been set or that the unit has been without power for longer than 48 hours. The time needs to be set to allow time schedules to operate.

Clock setup

Press OPTION > 2 sec. SEL and current time displayed Press RIGHT < 2 sec. to change time, Minutes blink: UP/DOWN to change, RIGHT to save minutes, Hours blink: UP/DOWN to change, RIGHT to save hour, Press RIGHT to save time, DAY1 blinks: UP/DOWN to change, RIGHT to save day (day of the week: DAY1 = Monday)	SEL 00:00 DAY1
------------------------------------------------------------------------------------------------------------------------------------------------------------------------------------------------------------------------------------------------------------------------------------------------------------------------------------	----------------------

Enable/disable time schedules

Press OPTION > 2 sec. SEL and current time displayed Press UP: SEL and PRO displayed, clock symbol blinks Press RIGHT: Time schedule status displayed OFF or ON: Press RIGHT OFF/ ON blinks, UP/DOWN to change, RIGHT to save	SEL PRO 	Pro OFF/ON
-------------------------------------------------------------------------------------------------------------------------------------------------------------------------------------------------------------------------------------------------	----------------	---------------

Creating time schedules

Step 1: Select a switching time (Up to 8, Pr01–Pr08)

Press UP while PRO-ON displayed: Large digits display Pr01, small digits display 00:00 Press RIGHT: 00:00 blinks Press UP/DOWN to select Pr01 switching time from 00:00–23:45 (15 minutes steps) Press RIGHT to save switching time (bar appears indicating step 1 complete): DAY 1 blinks	Pr01 08:00
-----------------------------------------------------------------------------------------------------------------------------------------------------------------------------------------------------------------------------------------------------------------------------------------------------------	-------------------

Step 2: Apply selected switching time (Pr01) to DAY1 (Mon) – DAY 7 (Sun)

While Pr01 is displayed and DAY1 is blinking: Press UP: Activate Pr01 switching time for DAY1 (triangle appears on 1), Press DOWN: Deactivate Pr01 switching time for DAY1(triangle disappears) Press RIGHT to save Pr01 DAY1 (2 nd bar indicates step 2 complete): Repeat for DAY2 – DAY7	Pr01 DAY1 1 2 3 4 5 6 7
-------------------------------------------------------------------------------------------------------------------------------------------------------------------------------------------------------------------------------------------------------------------------------------------------------------------------	---------------------------------------

Step 3: Select action for switching time (Pr01+Days)

After Pr01, DAY1–DAY7 is completed (Pr01 switching time activate or deactivate on desired days), press RIGHT again to come to desired action for Pr01. The following options appear in order: No = switching time not active OP = operation mode (select ON (Comfort/Occupied), ECO (Economy/Unoccupied), OFF) L1 = set point of loop 1 (select set point) L2 = set point of loop 2 (select set point) d1 = ON/OFF status of do1 (output must be in manual mode) d2 = ON/OFF status of do2 (output must be in manual mode) A1 = set point (0-100%) of ao1 (output must be in manual mode) Press UP/DOWN to scroll through the 7 possible actions (3 rd bar indicates step 3 complete) Press RIGHT to select one	Pr01 no
-----------------------------------------------------------------------------------------------------------------------------------------------------------------------------------------------------------------------------------------------------------------------------------------------------------------------------------------------------------------------------------------------------------------------------------------------------------------------------------------------------------------------------------------------------------------------------------------------------------------------------------------------------------------------------------------------------------------------------------------------------------	----------------

Step 4: Complete switching event (e.g. Pr01 = 08:00, DAY 1, Occupied mode)

After switching type is set, select characteristic of the action as listed in table above. Available actions blink as you scroll through them: Characteristics of action (e.g. 0–100% for A1) appear (4 th bar indicates step 4 complete) Press UP/DOWN to select characteristic of action, RIGHT to complete Repeat for Pr02 - Pr08	Pr01 40.0%
----------------------------------------------------------------------------------------------------------------------------------------------------------------------------------------------------------------------------------------------------------------------------------------------------------------------------------------------------------	-------------------

Setting parameters to configure the controller

TCI is an intelligent controller with the flexibility to fit a wide range of applications. The control operation is defined by parameters set using the standard operation terminal. There are two levels:

1. **User/display parameters (password 0009)**
2. **Control parameters (password 00241)**

Recommended set-up procedure

1. **Set jumpers on the back of the controller for inputs and outputs**
2. **Connect power supply and inputs**
3. **Make sure Celsius – Fahrenheit settings are correct (UP07)**
4. **Program input parameters**
5. **Program control parameters**
6. **Program output parameters**
7. **Program auxiliary functions and user settings**
8. **Test function of unit**
9. **Switch off power**
10. **Connect outputs**
11. **Test control loop**

Setting the Parameters

Parameters are grouped according to modules.

Module	Description	Notes	PW
UP	User and display parameters	Control user access and select display elements, regional settings	0009
1T, 1H, 1U, 2U	Input configuration	TCI-W22: Internal temp. and RH, 2 universal inputs TCI-W11: Internal temp. 1 universal input	0241
Lp1, Lp2	Control loops	TCI-W22: 2 independent control loops TCI-W11: 1 independent control loop	
AO1	Analog output configuration	1 analog output	
do1, do2	Binary output configuration	2 binary (digital) outputs - relays	
FU	Special functions	Common to all TCI	

How to change parameters

1. Press UP/DOWN $\Delta \nabla$ buttons simultaneously for three seconds. The display will show firmware version and revision number.
2. Press the RIGHT ● button to start login. CODE is shown in small display.
3. Code to access user parameters is 0009, control parameter is 0241. The access numbers are fixed and cannot be changed.
4. Select correct password using UP/DOWN $\Delta \nabla$ buttons.
5. Press RIGHT ● button after selecting the correct code.
6. Once logged in with 0009, the user/display parameters (UP) are displayed immediately. Once logged in with 0241 control modules are displayed (Lp1, Lp2, 1u, 2u, etc.) –select with UP/DOWN $\Delta \nabla$ and open with RIGHT ●. As soon as the module is open its parameters are displayed.
7. Select the parameters with the UP/DOWN $\Delta \nabla$ buttons. Change a parameter by pressing the RIGHT ● button. The symbol ✕ is displayed to indicate that the parameter may be modified. Use UP/DOWN $\Delta \nabla$ buttons to adjust the value.
8. After you are done, press RIGHT ● button to save the new value and return to the selection level (symbol ✕ disappears after selection is saved). Pressing left hand POWER ⏻ button without pressing RIGHT ● will discard the value and return without saving. For control parameters press POWER ⏻ again to leave parameter selection and return to control module selection.
9. Press the POWER ⏻ to leave the menu. The unit will return to normal operation if no button is pressed for more than 5 minutes.

User and display parameters (Password 009)

Parameter	Description	Range	Default
UP 00	Enable access to operation modes	ON/OFF	ON
UP 01	Enable access to set points	ON/OFF	ON
UP 02	Enable manual control in cascade	ON/OFF	ON
UP 03	Enable change of heating/cooling mode for 2 pipe systems	ON/OFF	ON
UP 04	Enable access to time programs:	ON/OFF	ON
UP 05	State after power failure: 0= off, 1= on, 2= state before power failure	0, 1, 2	2
UP 06	Enable Economy (unoccupied) Mode. Shift the setpoint to a lower temperature in winter or higher temperature in summer in order to save energy. Unoccupied (economy) mode may be activated through the POWER button, or with the external input (typically for key card switches in hotel rooms or motion detectors for meeting rooms.)	ON/OFF	ON
UP 07	Celsius or Fahrenheit: ON= Fahrenheit, OFF= Celsius	ON/OFF	OFF (Celsius)
UP 08	Show standard display while no key is pressed	ON/OFF	ON
UP 09	Select type of content for large digits (00= OFF):	0-5	1
	01= Input 02= Setpoint 03= Analog Output		
UP 10	Select content source for large digits (0=OFF):	0-4	1
	Input: 1= 1T 2= 1H 3= 1U 4= 2U		
UP 11	Select type of content for small digits (same options as UP09)	0-5	TCI-W11 = 2 TCI-W22 = 5
UP 12	Select content source for small digits (same options as UP10)	0-4	1
UP 13	Select analog output for vertical bar display (00= OFF):	0-4	3
	01= AO1 02= AO2		
UP 14	Display heating/cooling state in standard display mode	ON/OFF	OFF
UP 15	ON = Alarms blink after being active and need to be confirmed OFF= Alarms are only shown when they are active	ON/OFF	ON
UP 16 (TCI-W22)	Clock display type: OFF= 24-hr, ON= 12-hr(AM/PM)	ON/OFF	OFF(24hr)
UP 17 (TCI-W22)	Reset timer for manual override of PRO time schedule: 0= Not active 1-255= Delay for controller to go back to the scheduled Energy Hold OFF, Unoccupied (ECONOMY), or Occupied (COMFORT) operation mode if the operation mode is changed manually.	0-255 Min	60(Min)
UP 18 (TCI-W22)	OFF = Backlight switch on for 30 seconds when a key is pressed. ON = Backlight switch on constantly when device is in ON mode	ON/OFF	OFF

Control configuration (Password 241)

Input configuration

Internal inputs 1T temperature and 1H humidity (with added AES3-HT-A2, -A3 or -A5 element)

Parameter	Description	Range	Default	
1T 00	1H 00	Enable internal sensor	OFF/ON	ON
1T 01	1H 01	Display minimum value	-50-205	0
1T 02	1H 02	Display maximum value	-50-205	100
1T 03	1H 03	Sensor sampling rate (control speed decrease as rate increases)	0-100	10
1T 04	1H 04	Sensor calibration	per input	0
1T 05	1H 05	Alarm 1 (1T), Alarm 3 (1H) low limit	OFF/ON	OFF
1T 06	1H 06	Alarm 1 (1T), Alarm 3 (1H) low limit values	-40-215°C	5°C/5%
1T 07	1H 07	Alarm 2 (1T), Alarm 4 (1H) high limit	OFF/ON	OFF
1T 08	1H 08	Alarm 2 (1T), Alarm 4 (1H) high limit values	-40-215°C	50°C / 95%
1T 09	1H 09	Hysteresis Alarm 1, 2, 3, 4	0-100°	5°C/5%
1T 10	1H 10	Calculate a range of inputs (0= not active): 1= average, 2= minimum, 3= maximum, 4= differential	0-3	0

Universal inputs 1U = UI1, 2U = UI2 (TCI-W22-U only)

1U 00	Signal type (0= not active): 1= 0-10V or 0-20mA, 2= 2-10V or 4-20mA, 3= passive temperature	0-3	1
1U 01	Display minimum value	-50-205	0
1U 02	Display maximum value	-50-205	100
1U 03	Analog input display range: 0= x 0.1, 1= x 1, 2= x 10, 3= x 100	0-3	1
1U 04	Analog input unit of measure: 0= no unit, 1= %, 2= °C /°F, 3= Pa	0-3	2
1U 05	Sensor sampling rate (control speed decrease as rate increases)	0-100	10
1U 06	Sensor calibration	Per input	0
1U 07	Alarm 5 (1U), Alarm 7 (2U) low limit	OFF/ON	OFF
1U 08	Alarm 5 (1U), Alarm 7 (2U) low limit value	-40-215°C	5°C (41°F)
1U 09	Alarm 6 (1U), Alarm 8 (2U) high limit	OFF/ON	OFF
1U 10	Alarm 6 (1U), Alarm 8 (2U) high limit value	-40-215°C	50°C (122°F)
1U 11	Hysteresis alarm 5 and 6 (1U), alarm 7 and 8 (2U)	0-100°	5°C (10°F)
1U 12	Calculate a range of inputs (0=not active): 1= average, 2= minimum, 3= maximum, 4= differential	0-4	0

- ➔ Set jumpers on the back of the controller: 0-10VDC (default), 0-20mA, or RT/DI (passive temperature or binary)
- ➔ Further define analog inputs with U00
- ➔ Match sensor range to input display. With a differential pressure transmitter having 0-200 Pa measuring range set U01 display minimum to 0 and U02 display maximum to 200. The allowable range value of -50-205 may be adjusted with multipliers inU03. The largest displayable values are -990-9999. Limiting range increases resolution. Applies to analog as well as passive temperature inputs.
- ➔ For binary input (open/close contact) set the jumper to RT/DI and parameter U00 to an analog input. An open contact reads as a high value (100%), a closed contact as a low value (0%).
- ➔ Enable / Disable an alarm. Setting the alarm enable to OFF will prevent the alarm from being displayed on screen. It may never the less be used to control an output by setting the appropriate output alarm flags. This way, an alarm limit may be used as interlock.
- ➔ Specify the input value that triggers an alarm. Hysteresis is the difference between alarm level input and value required to turn the alarm off. An alarm is displayed as text if enabled (see table). Alarm text can be set to blink continuously until acknowledged by pressing the OPTION button or only while the alarm conditions are active (see user parameter UP15).

Input	1T	1H	1U	2U
Low limit	ALA1	ALA3	ALA5	ALA7
High limit	ALA2	ALA4	ALA6	ALA8

- ➔ Calculate mathematical functions over multiple inputs for loop control or display with xU12. In order to calculate average, minimum or maximum between several inputs, make sure all the inputs are of identical type and range and then activate the same function on xU12 on all the selected inputs. The largest input of the group selected will carry the calculated value. For example: When average is activated on 2U12 and 1U12 = 1, the average is carried on UI2.UI2 may now be used as input for control loops and it will show the average value of UI1 and UI2 combined. It is possible to use different functions on different inputs. For example: minimum of UI1 and UI3 and maximum of UI2 and UI4.
- ➔ The differential function may only be calculated on subsequent inputs. Such as UI2-UI1. The function must only be activated on the minuend (UI2 in this example). The displayed value of the minuend will change into the difference: UI2 in - UI1 = UI2 out. It is possible to have multiple differentials on one controller. It is not possible to reverse the subtraction to UI1-UI2.

Control loop configuration

Manipulation of the setpoint (1L and 2L)

Parameter	Description	Range	Default
1L 00	Select loop control input (0= loop disabled): 1= 1T, 2= 1H, 3= 1U, 4= 2U	0-4	1
1L 01	Minimum set point limit heating	per input	10°C (50°F)
1L 02	Maximum set point limit heating	per input	28°C (82°F)
1L 03	Minimum set point limit cooling	per input	18°C (64°F)
1L 04	Maximum set point limit cooling	per input	34°C (93°F)
1L 05	Enable set point compensation (0= disabled) 1= winter compensation, 2= summer compensation, 3= winter and summer	0-3	0
1L 06	Loop input special (0= normal): 1= combine loop 1 and loop 2 2= cascade with reverse sequence of primary loop 3= cascade with direct sequence primary loop 4= cascade with both reverse and direct sequence of primary loop	0-4	0
1L 07	Unoccupied (economy) mode set point shift: (Function depends on 1L25) The occupied (comfort) setpoint is shifted by the value set with parameter. Reduces the heating set point and increases the cooling set point.	per input	5.0°C(10°F)
1L 08	Dead zone between heating and cooling set points The Dead Zone Span lies between the heating and the cooling setpoint. The output is off while the measured value is within the dead zone span. A negative dead zone is not possible.	Per input	1.0°C (2°F)
1L 25	Fixed setpoint in Unoccupied (ECONOMY) mode OFF = Unoccupied (ECONOMY) set point shift applies ON = In Unoccupied (ECONOMY) mode use minimum setpoint limit as setpoint in heating mode or maximum setpoint limit in cooling mode	ON, OFF	OFF
1L 26	Setpoint compensation range, the maximum range the setpoint is shifted. 0 = Temperature setback: the setpoint is shifted towards setpoint limit	Acc input	0.0°C
1L 27	Do not show current value in loop mode OFF = Current value is shown in loop mode in the large digits. The setpoint in the small ones. ON = Current value is not shown, the setpoint is shown in the large digits.	ON, OFF	OFF

→ Unoccupied (economy) mode setpoints: There are two possibilities to change the setpoint in unoccupied (economy) mode: Shift it by L07 or switch to the minimum setpoint limit in heating mode and maximum setpoint limit in cooling. Unoccupied (economy) mode may be disabled by setting UP06 to OFF.

→ Control loops and sequences are activated when output parameters are defined.

→ Cascade control

In cascade control (L06) the setpoint of the secondary loop is determined by the demand of the primary loop. The setpoint of the secondary loop is calculated proportionally according to demand of the primary loop between minimum and maximum setpoint limits. Cascade control is activated by setting the parameter XL06 of the secondary control loop.

A typical application is a variable air volume system where the temperature output determines the pressure set point.

Cascade Control Example – VAV Application	
Primary loop = temperature (1L)	Secondary loop = airflow/pressure (2L)
	Settings: 2L01=20%, 2L02=60%, 2L06=2
Depending on temperature setpoint, the demand is calculated for loop 1. For example 40%.	Based on demand of loop 1, the setpoint of pressure loop is calculated proportionally between min (20%) and max (60%) pressure setpoint limits. A demand of 40% will result in a setpoint of 36% in the above example.

→ Setpoint Compensation

The setpoint compensation is typically used to compensate the set point due to a change in outside temperature. The relationship to the input used to drive the setpoint compensation is defined in auxiliary functions FU00 to FU07.

→ Enable summer or winter set point compensation for this control loop with L05. Define the compensation range with L26.L26 defines the full setpoint shift once the compensation input has reached its lower limit in winter mode or upper limit in summer mode.

Setting the range parameter to 0 will activate the setpoint setback function: The setback function shifts the set point toward the set point minimum or the set point maximum based on an external input value. Once the compensation input has reached its lower limit in winter mode or upper limit in summer mode, the setpoint is fixed to the setpoint minimum or maximum value. Commonly this is used for humidity control to avoid condensation on outside walls or windows in very cold weather.

PI control sequence

Parameter	Description	Range	Default
1L 09	Offset for heating PI sequence	per input	0
1L 10	Offset for cooling PI sequence	per input	0
1L 11	P-band heating	per input	2.0°C (4.0°F)
1L 12	P-band cooling	per input	2.0°C (4.0°F)
1L 13	Integral gain heating (0.1 steps) low= slow reaction, high= fast reaction	0-25.5	0.0
1L 14	Integral gain cooling (0.1 steps)	0-25.5	0.0
1L 15	Measuring interval integral (seconds) low= fast reaction, high value= slow reaction	0-255	1 sec.

→ **Proportional control(P-band)**

The proportional control function calculates the output based on the difference between setpoint and measured value. The proportional band (P-band) defines the difference between setpoint and measured value which will result in a 100% output. For example, with a heating or reverse 0-10 V control sequence, and a 2.0°C (4.0°F) P-band value, at 10 V the controller will be 2.0°C (4.0°F) below setpoint. This is the working range of the proportional control sequence.

Setting the proportional band to 0 disables proportional control.

→ **Integral and Differential control**

Proportional control is in most cases a very stable control mode. The flaw of proportional control alone, however, is that the setpoint is normally not reached. As the measured value gets closer to the setpoint, the output reduces until it reaches a point, a fraction above or below the setpoint, where the output equals the load. To reach the setpoint and achieve a higher level in comfort the Integral/Differential function should be activated.

Integral Gain (KI) dynamically increases the output by the selected KI value every **Measuring Interval TI** until the setpoint is reached. The challenge is to prevent hunting, where the output increases too fast, the temperature overshoots the setpoint, the output goes to 0, the temperature undershoots the setpoint, and the cycle repeats itself. Hunting may result if the integral gain is too high or measuring interval too short. Each system is different. To prevent instability the P-band should be extended when integral gain is active (L14 or L15 set above 0).

Setting the integral gain to 0 disables integral and differential control.

Recommended Values						
	heating (air)	heating (radiant)	humidifying	cooling	dehumidifying	pressure
P-band	2-3°C (4-6°F)			1-1.5°C (2-3°F)		
Measuring interval (TI)	2	5	15	1	70	1
Integral gain (KI)	0.2	0.1	0.1	0.2	0.3	0.8

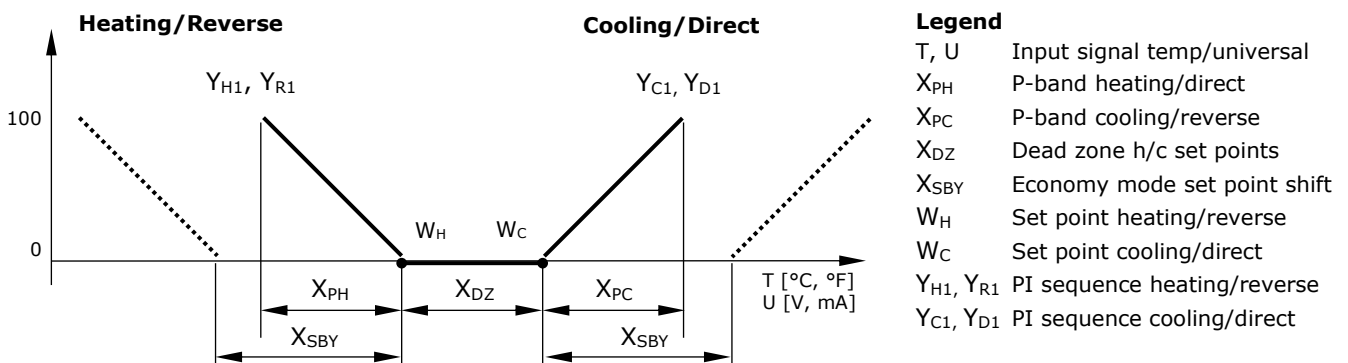

Digital control sequence

Parameter	Description	Range	Default
1L 16	Action of stages: 0= cumulative: stage 1 stays on when 2 on comes on 1= single: stage 1 turns off when 2 on comes on 2= digital: stage 1 only, stage 2 only, then stage 1 plus 2	0-2	0
1L 17	Offset for heating/reverse binary sequences	per input	0.0°C (0.0°F)
1L 18	Offset for cooling/direct binary sequences	per input	0.0°C (0.0°F)
1L 19	Switching span heating	per input	1.0°C (2.0°F)
1L 20	Switching span cooling	per input	1.0°C (2.0°F)
1L 21	Switching hysteresis	per input	0.5°C (1.0°F)
1L 22	Switching delay	0-255s	10s
1L 23	Activation of reverse/direct (heat/cool) sequence OFF= activates based on demand ON = follows heat/cool state of controller: Set manually or by auxiliary function (FU20-FU23)	ON/OFF	OFF
1L 24	Delay for heat /cool changeover when L23=OFF	0-255 min	5 min

➔ Cumulative stage action (L16=0) is typically used in electric heat applications, and single stage action (L16=1) in fan speed applications. Digital stage action (L16=2) is especially useful in electric heat applications to generate three steps with just two outputs. For example: Step 1=100W, step 2=200W, step 3=300W.

	Cumulative	Single	Digital
Stage 1	Q ₁	Q ₁	Q ₁
Stage 2	Q ₁ +Q ₂	Q ₂	Q ₂
Stage 3			Q ₁ +Q ₂

➔ Switching hysteresis (L21) is the difference between switching on and switching off. A small hysteresis will increase the number of switching cycles and thus the wear on associated equipment.

➔ With switching delay (L22) cumulative stages will not switch on simultaneously. With a sudden demand or initial power stage 2 will not start earlier than 10 seconds (default value) after stage 1 has been initiated.

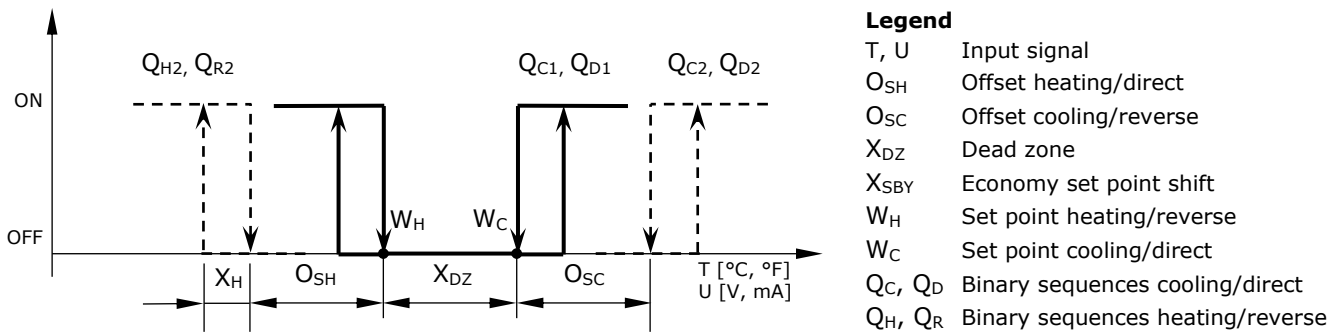

Output configuration

Analog output configuration (1A)

Parameter	Description	Range	Default
1A 00	Select control loop or special function (0= OFF): 1= LP1, 2= LP2 3= Dehumidify (4 pipe, max LP1 cooling, LP2 direct) 4= Manual positioning or by time schedule (0-100%) 5= Transmit value of an input	0-5	1
1A 01	When 1A00 = 1 configure output: 0= Heating/reverse 1= Cooling/direct 2= Heating and cooling (2 pipe) 3= Transmit setpoint When 1A00 = 4 Manual positioning or time schedule controlled 0 = time schedule only 1 = manual positioning and by time schedule When 1A00 = 5, select input (0= function disabled): 1= 1T, 2= 1H, 3= 1U, 4= 2U	0-4	0
1A 02	Type of output signal: OFF= 0-10V, 0-20mA, ON= 2-10V, 4-20mA	ON/OFF	OFF
1A 03	Minimum limitation of output signal default and in loop heating mode	0-100%	0
1A 04	Maximum limitation of output signal default and in loop heating mode	0-100%	100%
1A 05	Minimum limitation of output signal in loop cooling mode	0-100%	0%
1A 06	Maximum limitation of output signal in loop cooling mode	0-100%	100%
1A 07	Choose alarm to set output to 100% (output 0% on conflicting alarms) ▽▽▽▽▽▽▽▽ Alarm: 1 2 3 4 5 6 7 8	ALA1-ALA8	▽▽▽▽▽▽▽▽
1A 08	Choose alarm to set output to 0%. (output 0% on conflicting alarms) ▽▽▽▽▽▽▽▽ Alarm: 1 2 3 4 5 6 7 8	ALA1-ALA8	▽▽▽▽▽▽▽▽
1A 09	Transmit value (1A00=5): minimum input value	per input	0°C
1A 10	Transmit value (1A00=5): maximum input value	per input	100°C

- Set jumpers on the back of the controller: 0-10 VDC (default), or 0-20 mA. Further define analog outputs with A02. Custom ranges can be created by setting minimum and maximum signal limits.
- A control loop, special function, digital control or analog control sequence is not active until it is assigned an output.
- Low and high limit alarms are defined with input parameters. With output parameters assign an alarm to an output and select output state. The required output for each alarm can be individually selected. Multiple alarms can be signed to one output. If one alarm is selected to simultaneously activate and deactivate an output, the one to de-activate has precedence.
- With manual positioning (1A00=4) position the output by time schedule or directly in 0.5% steps. Setting 1A01 to 0 will disable manual positioning. The output will then only be controlled by time schedule.
- With dehumidifying (1A00=3) the maximum value is taken of cooling and dehumidifying. When the humidity is too high, cooling will continue to operate, even without a demand for cooling, to dehumidify the air and heating will activate to maintain comfort.
- Input values of inputs and set points of control loops may be transmitted on the analog outputs.
- **Minimum or maximum limits of output signals may be reversed.** This allows to create a control option for example of 6-way valves where the following conditions are required: 0% full cooling, 50% no cooling or heating, 100% full heating. This is achieved by setting 1A05 = 50%, 1A06 = 0%, 1A03 = 50% and 1A04 = 100%. While one sequence is reversed and the other is direct, the output will remain in OFF mode at the percentage defined with the last active minimum sequence.
 Note: Alarm values will not be affected by minimum or maximum limits.

<p>Output Priority</p> <ol style="list-style-type: none"> 1. Alarm level low 2. Alarm level high 3. Operation mode OFF 4. Control function

→ For **VAV Function** individual minimum and maximum limits may be assigned for cooling and heating. In VAV applications maximum cooling output matches the maximum air volume the VAV box is set to deliver. As demand for airflow in cooling mode decreases, airflow dwindles until it reaches minimum cooling output (1A05). This minimum will be based on the airflow needed at design cooling and is typically 10% to 15% of maximum cooling airflow. When this minimum is reached the system is in dead-band - neither heating nor cooling. Minimum airflow in heating mode is set with 1A03. As the system moves into heating mode, heating airflow increases until it reaches the maximum heating output (1A04), typically 30 to 50% of maximum cooling airflow.

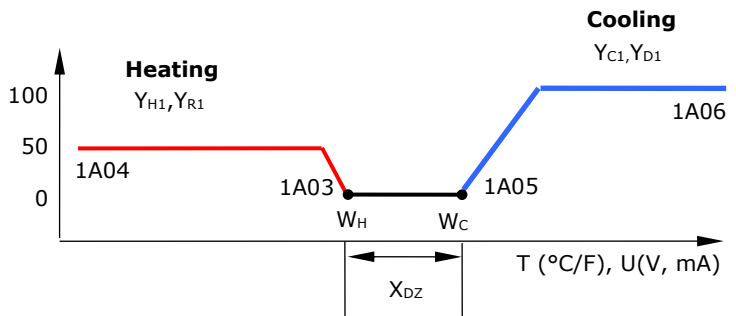

Digital output configuration (1d, 2d)

Settings for digital outputs (1d00 / 2d00 = OFF, 1d05 / 2d05 = 0), 1d = DO1, 2d = DO2

Parameter	Description	Range	Default
1d 00	Enable digital/PWM or floating point (3-point valve) output OFF= DO1 and DO2 are two digital/PWM outputs ON = DO1 and DO2 are one floating point output (DO1 open, DO2 close)	ON/OFF	OFF
1d 01	Select control loop or special function (0= OFF) 1= LP1, 2= LP2 3= Dehumidify (4 pipe, max LP1 cooling, LP2 direct) 4= Manual positioning (on/off) 5= State functions	0-5	0
1d 02	When 1d01 = 1, configure output: 0= Stage 1 heating/reverse 1= Stage 1 cooling/direct 2= Stage 1 heating and cooling, reverse and direct 3= Stage 2 heating/reverse 4= Stage 2 cooling/direct 5= Stage 2 heating and cooling, reverse and direct If 1d01 = 4 Manual positioning or time schedule controlled 0= Time schedule controlled only 1= Manual positioning and time schedule controlled When 1d01 = 5, select state functions: 0= ON if controller operation state is ON 1= ON while demand on any output 2= ON while controller in heating mode and operation state ON 3= ON while controller in cooling mode and operation state ON	0-5	0
1d 03	Switch-off delay (time output active with no more demand) Delay is in seconds or minutes depending on d09	0-255	90sec
1d 04	Switch-on delay(time demand active before output on) In state mode 1d01=5 outputs disabled during switch-on delay Delay is in seconds or minutes depending on d09	0-255	5 sec
1d 05	Activate PWM, set cycle time, seconds (>0 activates, 0 deactivates)	0-1650s	0s
1d 06	Choose alarm to set output to ON (output OFF on conflicting alarms) ▽▽▽▽▽▽▽▽ Alarm: 1 2 3 4 5 6 7 8	ALA1-ALA8	▽▽▽▽▽▽▽▽
1d 07	Choose alarm to set output to OFF (output OFF on conflicting alarms) ▽▽▽▽▽▽▽▽ Alarm: 1 2 3 4 5 6 7 8	ALA1-ALA8	▽▽▽▽▽▽▽▽
1d 08	Display fan symbol while active	ON/OFF	OFF
1d 09	Binary switching delays in minutes or seconds OFF = delays are in seconds, ON = delays are in minutes	ON, OFF	OFF

- ➔ Low and high limit alarms are defined with input parameters. With output parameters assign an alarm to an output and select output state. Each alarm's required output can be individually selected. Multiple alarms can be signed to one output. Should one alarm be simultaneously selected to activate and deactivate the output, the one to de-activate has precedence.
- ➔ With manual positioning (1d01=4) position the output directly (ON/OFF).
- ➔ With dehumidifying (1d01=3) the maximum value is taken of cooling and dehumidifying. When the humidity is too high, cooling will continue to operate, even without a demand for cooling, to dehumidify the air and heating will activate to maintain comfort.
- ➔ State functions (1d01=5) activate the output based on certain conditions with or without a demand for heating or cooling, in either occupied (comfort) or unoccupied (standby) mode. In Energy Hold OFF mode (EHO) the output will be off.

<p>Output Priority</p> <ol style="list-style-type: none"> 1. Alarm level low 2. Alarm level high 3. Operation mode OFF 4. Control function

Digital output configuration (1d, 2d)

Settings for PWM outputs (1d00 / 2d00 = OFF, 1d05 / 2d05 > 0), 1d = DO1, 2d = DO2

Parameter	Description	Range	Default
1d 00	Enable digital/PWM or floating point (3-point valve) output OFF= DO1 and DO2 are two digital/PWM outputs ON = DO1 and DO2 are one floating point output (DO1 open, DO2 close)	ON/OFF	OFF
1d 01	Select control loop or special function (0= OFF) 1= LP1, 2= LP2 3= Dehumidify (4 pipe, max LP1 cooling, LP2 direct) 4= Manual positioning (on/off) 5= State functions	0-5	0
1d 02	When 1d01 = 1, configure output: 0= Stage 1 heating/reverse 1= Stage 1 cooling/direct 2= Stage 1 heating and cooling, reverse and direct 3= Stage 2 heating/reverse 4= Stage 2 cooling/direct 5= Stage 2 heating and cooling, reverse and direct If 1d01 = 4 Manual positioning or time schedule controlled 0= Time schedule controlled only 1= Manual positioning and time schedule controlled When 1d01 = 5, select state functions: 0= ON if controller operation state is ON 1= ON while demand on any output 2= ON while controller in heating mode and operation state ON 3= ON while controller in cooling mode and operation state ON	0-5	0
1d 03	Minimum PWM duty cycle limit ¹⁾	0-100%	See Note
1d 04	Maximum PWM duty cycle limit ¹⁾	0-100%	See Note
1d 05	Activate PWM, set cycle time, seconds (>0 activates, 0 deactivates)	0-1650s	0s
1d 06	Choose alarm to set output to ON (output OFF on conflicting alarms) ▽▽▽▽▽▽▽▽ Alarm: 1 2 3 4 5 6 7 8	ALA1-ALA8	▽▽▽▽▽▽▽▽
1d 07	Choose alarm to set output to OFF (output OFF on conflicting alarms) ▽▽▽▽▽▽▽▽ Alarm: 1 2 3 4 5 6 7 8	ALA1-ALA8	▽▽▽▽▽▽▽▽
1d 08	Display fan symbol while active	ON/OFF	OFF
1d 09	Not used	ON, OFF	OFF

- ➔ Low and high limit alarms are defined with input parameters. With output parameters assign an alarm to an output and select output state. Each alarm's required output can be individually selected. Multiple alarms can be signed to one output. Should one alarm be simultaneously selected to activate and deactivate the output, the one to de-activate has precedence.
- ➔ With manual positioning (1d01=4) position the output directly (ON/OFF).
- ➔ With dehumidifying (1d01=3) the maximum value is taken of cooling and dehumidifying. When the humidity is too high, cooling will continue to operate, even without a demand for cooling, to dehumidify the air and heating will activate to maintain comfort.
- ➔ State functions (1d01=5) activate the output based on certain conditions with or without a demand for heating or cooling, in either occupied (comfort) or unoccupied (standby) mode. In Energy Hold OFF mode (EHO) the output will be off.
- ➔ Pulse width modulation (PWM) mode is enabled with 1d05. In PWM mode the digital output will be switched on/off once per cycle. The on and off times are calculated according to the PI settings of the respective control sequence (see control loop Parameters L09-L15, page 13). TCI-W11-U and TCI-W22-U use relays for the digital outputs.

Output Priority
1. Alarm level low
2. Alarm level high
3. Operation mode OFF
4. Control function



Important Note!

If you enable PWM function, the meaning of parameter 1d03/2d03 and 1d04/2d04 changes to duty cycle limits!

Make sure the values of 1d03/2d03 and 1d04/2d04 are set correctly!

Recommended default: 1d03/2d03 = 0%, 1d04/2d04 = 100%.



It is not recommended to use cycle times below 100 seconds as the lifetime of the relays will be shortened with frequent switching. For PWM applications requiring cycle times below 100 seconds we recommend using TCY-FT with TRIAC outputs.

1) The PWM duty cycle signal is not spanned between the min and max settings. It is just cut off. Any output percentage below the min will be fixed at the minimum time. Any output percentage above the maximum will be fixed to the output maximum.

Digital output configuration (1d, 2d)

Settings for floating point (3-point valve) outputs (1d00 = ON), 1d = DO1 = open, 2d = DO2 = close

Parameter	Description	Range	Default
1d00	Enable digital/PWM or floating point (3-point valve) output OFF= DO1 and DO2 are two digital/PWM outputs ON = DO1 and DO2 are one floating point output (DO1 open,DO2 close)	ON/OFF	OFF
1d01	Select control loop or special function (0= OFF) 1= LP1, 2= LP2 3= Dehumidify (4 pipe, max LP1 cooling, LP2 direct) 4= Manual positioning (open/close) 5= Controller state functions	0-5	0
1d02	If 1d01 = 1 configure output: 0=Heating/reverse 1= Cooling/direct 2= Heating and cooling (2 pipe) If 1d01 = 4 Manual positioning or time schedule controlled 0= Time schedule controlled only 1= Manual positioning and time schedule controlled If 1d01 = 5 select state functions: 0= ON if controller operation state is ON 1= ON while demand on any output 2= ON while controller in heating mode and operation state ON 3= ON while controller in cooling mode and operation state ON	0-5	0
1d03	Running time (from open to close)	0-255s	90s
1d04	Switching difference for floating point signal	0-100s	5s
1d05	Not used		
1d06	Choose alarm to set output to 100% (output 0% on conflicting alarms) ▽▽▽▽▽▽▽▽ Alarm: 1 2 3 4 5 6 7 8	ALA1-ALA8	▽▽▽▽▽▽▽▽
1d07	Choose alarm to set output to 0% (output 0% on conflicting alarms) ▽▽▽▽▽▽▽▽ Alarm: 1 2 3 4 5 6 7 8	ALA1-ALA8	▽▽▽▽▽▽▽▽
1d08	Not used		
1d 09	Not used		

- ➔ Low and high limit alarms are defined with input parameters. With output parameters assign an alarm to an output and select output state. Each alarm's required output can be individually selected. Multiple alarms can be signed to one output. Should one alarm be simultaneously selected to activate and deactivate the output, the one to de-activate has precedence.
- ➔ With manual positioning (1d01=4) position the output directly (open/close).
- ➔ With dehumidifying (1d01=3) the maximum value is taken of cooling and dehumidifying. When the humidity is too high, cooling will continue to operate, even without a demand for cooling, to dehumidify the air and heating will activate to maintain comfort.
- ➔ State functions (1d01=5) activate the output based on certain conditions with or without a demand for heating or cooling, in either occupied (comfort) or unoccupied (standby) mode. In Energy Hold OFF mode (EHO) the output will be off.
- ➔ For floating point (3-point valve) outputs, the running time of the actuator used needs to be specified with 1d03. Running time is defined as the time required for the actuator to run from fully open to fully closed and vice versa. Actuators with a fixed running time are recommended. Once fully open or fully closed the running time for the actuator is extended for a full run-time cycle. This will allow the actuator position to be synchronized in case it has been moved during off time or an actuator with variable running time was used. Use switching difference parameter 1d04, to reduce the switching frequency of the actuator. The actuator will only move if the difference to the current actuator position is larger than this parameter.

<p>Output Priority</p> <ol style="list-style-type: none"> 1. Alarm level low 2. Alarm level high 3. Operation mode OFF 4. Control function

Auxiliary functions

Summer/winter compensation

Parameter	Description	Range	Default
Fu 00	Select compensation input (0= function disabled): 1= 1T, 2= 1H, 3= 1U, 4= 2U	0-4	0
Fu 01	Winter compensation setpoint setback OFF= shift toward control loop heating set point minimum ON= shift toward control loop heating set point maximum	ON/OFF	OFF
Fu 02	Winter compensation lower limit value – end shift	per input	5°C (41°F)
Fu 03	Winter compensation upper limit value – start shift	per input	20°C (68°F)
Fu 04	Summer compensation setpoint setback OFF= shift toward control loop cooling set point minimum ON= shift toward control loop cooling set point maximum	ON/OFF	ON
Fu 05	Summer compensation lower limit value – start shift	per input	35°C (95°F)
Fu 06	Summer compensation upper limit value – end shift	per input	40°C (104°F)
Fu 07	Show hot/cool symbol while compensation active	ON/OFF	OFF

Occupied (comfort)/Unoccupied (economy) mode changeover

Fu 08	Select comfort/economy changeover input (0= disabled): 1= 1T, 2= 1H, 3= 1U, 4= 2U	0-4	0
Fu 09	Unoccupied (economy) activation delay (seconds)	-1275s	300s
Fu 10	Input limit 1	per input	10
Fu 11	Input limit 2	Per input	90

→ Summer/winter compensation changes the set point due to a change in an input value, typically, but not limited to, an outdoor temperature input. Winter compensation starts when outside temperature drops below the upper limit of winter compensation (FU03). At maximum winter compensation the actual set point will be equal to the control loop's maximum heating set point (L02). Summer compensation starts when outside temperature exceeds the lower limit for summer compensation (FU05). At maximum summer compensation the actual set point will be equal to the control loop's maximum cooling set point (L04). Activate summer/winter compensation with control loop configuration parameter(L05).

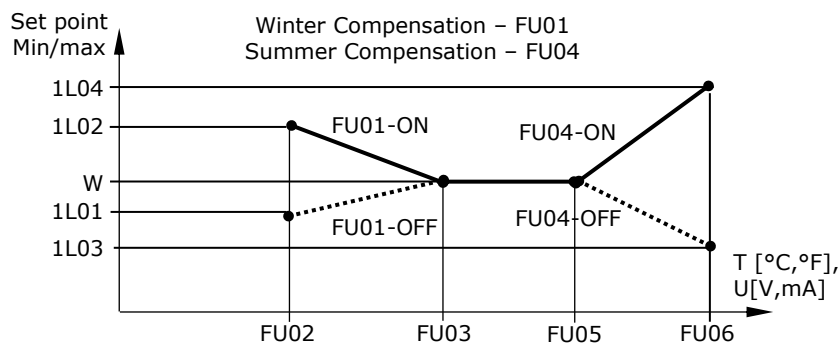

→ Use Occupied (comfort)/Unoccupied (economy) mode changeover with key card switches, occupancy sensors, etc. Set input limit 1 and 2 with possibilities below. Example: When Limit 2 is greater than Limit 1, switch comfort-to-economy at the lower value, economy-to-comfort at the higher value. Activate occupied (comfort)/unoccupied (economy) changeover with loop configuration parameter(L07).

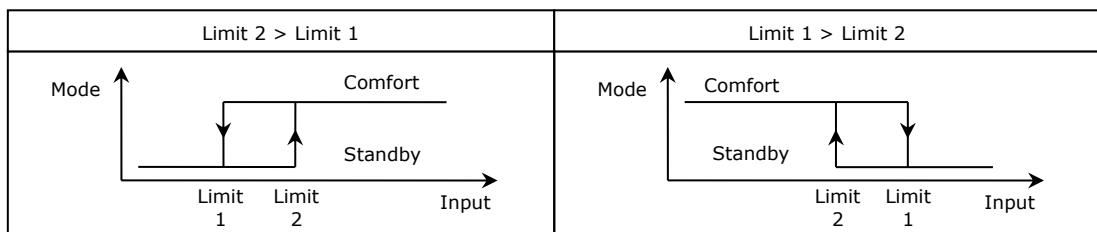

Enable/disable

Parameter	Description	Range	Default
Fu 12	Select enable–disable input (0=function disabled): 1= 1T, 2= 1H, 3= 1U, 4= 2U	0–4	0
FU 13	Manual override permitted (without waiting for delay). This function allows starting the controller, even the enable conditions are not met. The controller will switch off again if the running conditions are not met until the disable delay is expired.	ON/OFF	OFF
Fu 14	Enable delay (seconds)	0–1275s	0
Fu 15	Disable delay (seconds)	0–1275s	300
Fu 16	Range of limits: OFF = When limit 2 is greater than limit 1, enable when input value is greater than limit 2,disable when input value is less than limit 1. When limit 2 is less than limit 1, enable when input value less than limit 1, disable when input value is greater than limit 2. ON = When limit 2 is greater than limit 1enable when input value is between limit 1 and limit 2. When limit 2 is less than limit 1, enable when input value below limit 2 or above limit 1	ON/OFF	OFF
Fu 17	Input limit 1	per input	10
Fu 18	Input limit 2	Per input	90
Fu 19	Disable in case of alarms	Selection	▽▽▽▽▽▽▽▽

➔ Enable or disable the controller based on desired input values, such as high or low temperature, occupancy sensor, window contact, etc. Can be used as *and* function where several conditions must be met before disable or enable. Time schedules do not override, but manual override is permitted. Delay times may be assigned for both enable and disable (allows for the controller to start before validation of operation values takes place). Set input limit 1 and 2 with options below. Example: With FU16=OFF, and Limit 2 > Limit 1, switch enable-to-disable at Limit 1, disable-to-enable at Limit 2.

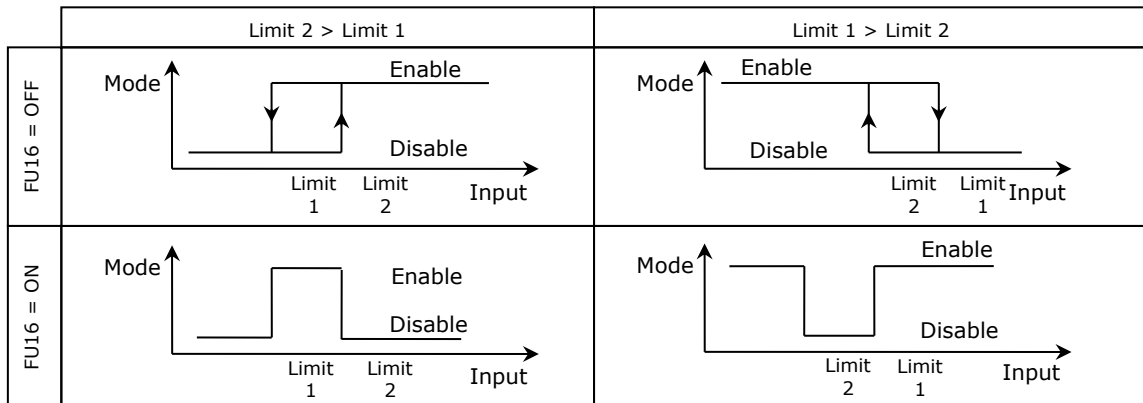

Heating/cooling mode changeover

Parameter	Description	Range	Default
Fu 20	Select heat/cool changeover input (0=function disabled): 1= 1T, 2= 1H, 3= 1U, 4= 2U, 5= h/c status loop 1, 6= h/c status loop 2	0-6	0
Fu 21	Cooling activation delay (seconds)	0-1275s	300
Fu 22	Input limit 1	per input	20
Fu 23	Input limit 2	per input	40

- ➔ Switch heating/cooling state based on a universal input value. The input may be from a supply media (air or water) or outdoor air temperature sensor. For supply media temperature we recommend switching to cooling at 16°C/61°F and to heating at 28°C/83°F. For outdoor temperature we recommend switching to cooling at 28°C/83°F and to heating at 16°C/61°F outdoor temperature. These recommendations are given as suggestions. The ideal settings may be different on the actual project depending on climatic and system conditions.
- ➔ The change between heating and cooling is delayed to avoid unnecessary switching (FU21). Heat/cool status of one control loop may also be determined by the heat/cool state of the other loop (FU20= 5 or 6). The control loop used to determine the heat /cool state must be set to demand-based heating and cooling with (L23). Set limit 1 and limit 2 to switch between heating and cooling with options below. Example: When Limit 2 is greater than Limit 1, switch heat to cool at Limit 1, cool to heat at Limit 2. For binary open/close contact, open is a high value (100%), closed is a low value (0%).

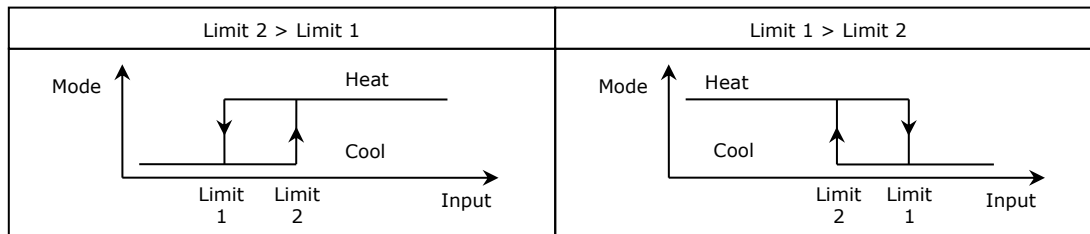

**Smart Sensors and Controls
Made Easy!**

Quality - Innovation – Partnership

Vector Controls GmbH
Switzerland

info@vectorcontrols.com
www.vectorcontrols.com

